



Severn Estuary Shoreline Management Plan Review

Appendix C:
Baseline Understanding of
Coastal Behaviour and Dynamics
Coastal Defences
Baseline Scenarios



ATKINS



Severn Estuary Shoreline Management Plan Review (SMP2)

Appendix C : (A) Baseline Understanding of Coastal Behaviour and Dynamics, (B) Coastal Defences and (C) Baseline Scenario Report

December 2010

Notice

This report was produced by ABPmer and Atkins for the Severn Estuary Coastal Group for the specific purpose of the Severn Estuary Shoreline Management Plan Review (SMP2).

This report may not be used by any person other than the Severn Estuary Coastal Group without The Severn Estuary Coastal Group's express permission. In any event, Atkins accepts no liability for any costs, liabilities or losses arising as a result of the use of or reliance upon the contents of this report by any person other than the Severn Estuary Coastal Group.

Document History – Parts A and B: Coastal Behaviour, Dynamics and Defences

JOB NUMBER: 5078599			DOCUMENT REF: Coastal Behaviour, Dynamics and Defences Task 2.1			
01	Draft for Stakeholder Comment – PART A	ABPMer	KW	JMcC	RS	7 May 2009
02	Draft for Stakeholder Comment – PART B	PC	KW	JMcC	RS	7 May 2009
03	Final Draft – PART B	CW	PC	JMcC	RS	31 July 2009
04	For PMG Review	SB	PC	JMcC	RS	2 Sept 2009
05	Final Draft for QRG Review	SB	KW	JM	RS	25 May 2010
06	Final Draft for QRG Review	SB	KW	JM	RS	Sept 2010
07	Final	KW	PC	PC	RS	Dec 2010
Revision	Purpose Description	Originated	Checked	Reviewed	Authorised	Date

Document History – Part C: Develop Baseline Scenarios

JOB NUMBER: 5078599			DOCUMENT REF: Develop Baseline Scenarios. Task 2.2			
01	First Internal Draft	SB	PC			8 May 2009
02	Second Internal Draft	CW	PC	JMcC	RS	31 July 2009
03	For PMG Review	SB	PC	JMcC	RS	2 Sept 2009
04	Final Draft for QRG Review	SB	KW	JM	RS	25 May 2010
05	Final Draft for QRG Review	SB	KW	JM	RS	Sept 2010
06	Final	KW	PC	PC	RS	Dec 2010
Revision	Purpose Description	Originated	Checked	Reviewed	Authorised	Date

Contents

Section	Page
Supporting Appendices	vi
Acronyms and Abbreviations	viii
Compliance to the SMP2 Quality Review Group (QRG) Terms of Reference	xii
Purpose of the Report	1
1. Introduction	7
1.1 Extent of the SMP	8
1.2 Structure of Part A	9
1.3 Assumptions and Limitations	9
2. Estuary Description and Processes	11
2.1 Overview	11
2.2 Geology and Coastal Evolution	12
2.3 Geomorphology	14
2.4 Present Estuary Behaviour	16
2.5 Hydrodynamics	17
2.6 Sediment Transport	23
3. Process Units and Shoreline Change	29
3.1 PU1 Penarth	31
3.2 PU2 Cardiff Bay	31
3.3 PU3 Wentlooge	32
3.4 PU4 River Usk	33
3.5 PU5 Uskmouth	33
3.6 PU6 Caldicot Levels	34
3.7 PU7 The Severn Crossings	34
3.8 PU8 River Wye	35
3.9 PU9 Beachley to Lydney Point and Sharpness	35
3.10 PU10 Lydney Point to Tites Point (Sharpness to Purton)	36
3.11 PU11 Tites Point to Hock Cliff	36
3.12 PU12 Hock Cliff to Longney Pool	37
3.13 PU13 Longney Pool to The Weirs	38
3.14 PU14 The Weirs to Haw Bridge	38
3.15 PU15 New Passage to Portishead	38
3.16 PU16 River Avon	39
3.17 PU17 Portishead to Clevedon	39
3.18 PU18 Kingston Seymour	40
3.19 PU19 Middle Hope	40
3.20 PU20 Sand Bay	40
3.21 PU22 The Holms	41
4. Assessment of Future Geomorphological Change	42
4.1 Climate Change	42
4.2 Future Geomorphological Change	42
5. References/Bibliography	45
PART B - Coastal Defence Report	60

PART C - Develop Baseline Scenarios	88
1. Aim of this Part	89
1.1. Approach	89
1.2. Baseline Scenarios	89
1.3. Climate Change and Sea Level Rise	90
1.4. The Severn Bore	91
Baseline Case 1 – No Active Intervention	92
Baseline Case 2 – With Present Management	119
Annex A SMP1 Policies	150
Annex B No Active Intervention Mapping	156
Annex C With Present Management Mapping	183

Supporting Appendices

Information required to support the Severn Estuary Shoreline Management Plan Review (SMP2) is provided in the following appendices. These supporting documents offer transparency to the decision making process that is undertaken, leading to explanations and reasoning for the promoted policies.

A: SMP2 Development	The history, structure and development of the SMP are detailed in this report. The investigation and decision making process are explained more fully to outline the procedure to setting policy.
B: Stakeholder Engagement and Consultation	Stakeholder communication is continuous through the SMP2 process, comments on the progress of the management plan are recorded within Appendix B.
C: Baseline Understanding of Coastal Behaviour and Dynamics, Coastal Defences and Baseline Scenario Report	This report includes detail of coastal dynamics, defence data and shoreline scenario assessments of NAI (No Active Intervention – defences are not maintained, repaired or replaced allowing the shoreline to evolve more naturally) and With Present Management (WPM) i.e.: SMP1 Policy.
D: Theme Review	The identification and evaluation of the natural landscape and conservation, the historic environment and present and future land use of the shoreline.
E: Issues, Features and Objectives	The features of the shoreline are listed within this report. A series of strategic objectives are then set along with commentary on the relative importance of each feature identified.
F: Policy Development and Appraisal	Presents the consideration of generic policy options for each frontage identifying possible acceptable policies and their combination into 'Management Approaches' for testing. Also presents the appraisal of impacts upon shoreline evolution and the appraisal of objective achievement.
G: Preferred Policy Management Approach Testing	Presents the policy assessment of appraisal of objective achievement towards definition of the Preferred Plan (as presented in the Shoreline Management Plan document).
H: Economic Appraisal and Sensitivity Testing	Presents the economic analysis undertaken in support of the Preferred Plan.
I: Strategic Environmental Assessment Report	Presents the various items undertaken in developing the Plan that specifically relate to the requirements of the EU Council Directive 2001/42/EC (the Strategic Environmental Assessment Directive), such that all of this information is readily accessible in one document. This includes work to help towards a Habitat Regulatory Assessment (HRA).
J: Water Framework Assessment Report	Provides a retrospective assessment of the policies defined under the Severn Estuary SMP2 highlighting future issues for consideration at policy implementation stage.
K: Bibliographic Database	All supporting information used to develop the SMP is referenced for future examination and retrieval.

The information presented in each appendix is supported and guided by other appendices; the broad relationships between the appendices are illustrated overleaf.

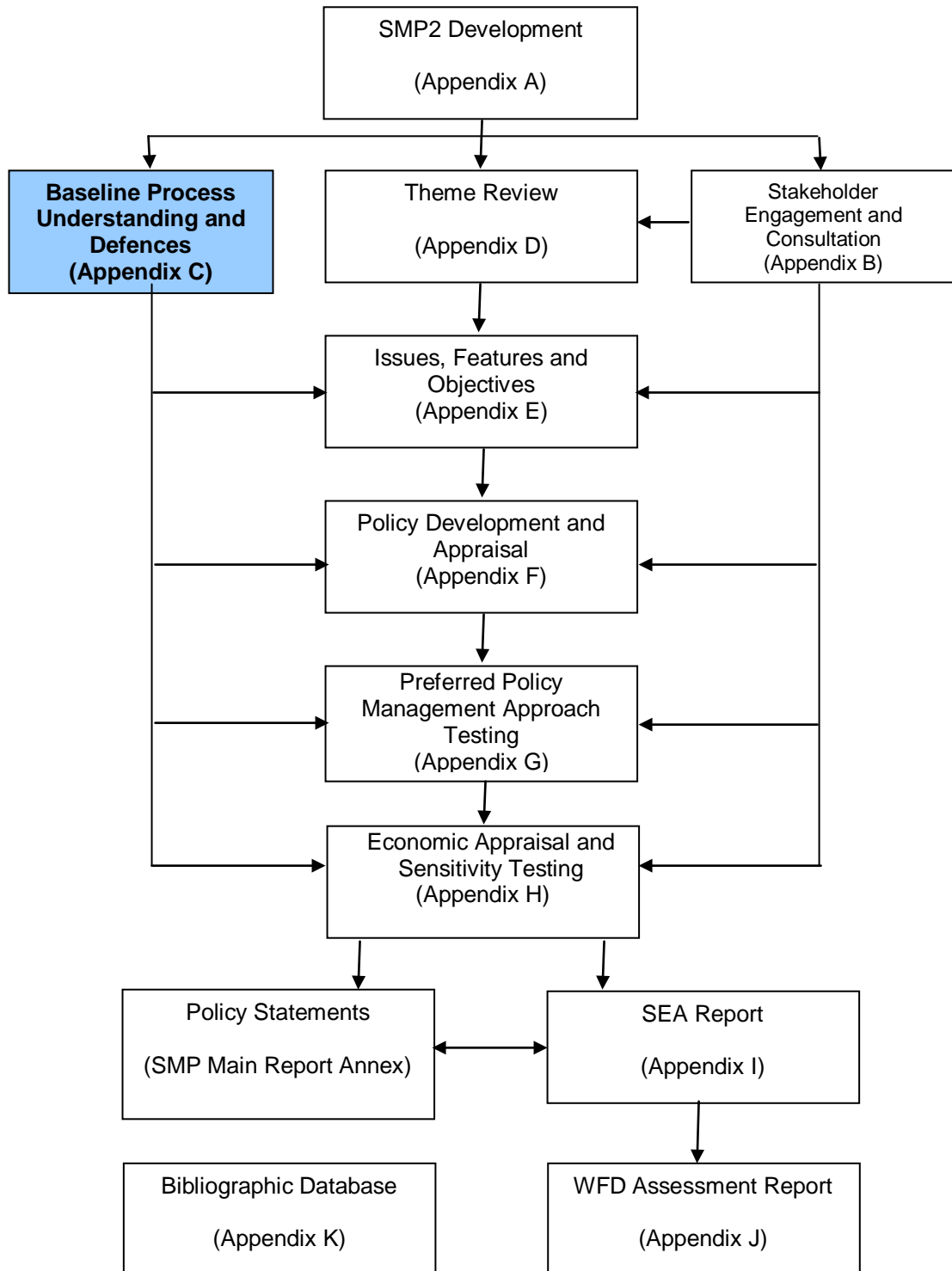

Acronyms and Abbreviations

Term	Definition
AA	Appropriate Assessment.
ABP	Association of British Ports
AEP	Annual Exceedance Probability
AONB	Area of Outstanding Natural Beauty.
ASERA	Association of Severn Estuary Relevant Authorities
ATL	Advance the Line
BAP	Biodiversity Action Plans
BCCPA	Bristol Channel Counter Pollution Association
BMIF	British Marine Federation
CAPE	Community Adaptation Planning and Engagement
CCW	Countryside Council for Wales
CD	Chart Datum.
CFMP	Catchment Flood Management Plan
CHaMP	<i>Coastal</i> Habitat Management Plan
CPSE	Coast Protection Survey England
CSG	Client Steering Group, principal decision-making body for the Shoreline Management Plan = Severn Estuary Coastal Group (SECG)
CV	Capital Value. The actual value of costs or benefits.
DCLG	Department of Communities and Local Government
DECC	<i>Department of Energy and Climate Change</i>
Defra	Department for Food, Environment and Rural Affairs.
EA	Environment Agency, may also be referred to as 'The Agency'
EH	English Heritage
EiP	Examination in Public
EMF	Elected Members Forum (SMP2), comprising an Elected Member from each of the Local Authorities
FCA	Flood Consequence Assessment
FCDPAG3	Flood and Coastal Defences Project Appraisal Guidance

Term	Definition
FCS	Favourable Conservation Status
SEFRMS	Severn Estuary Flood Risk Management Strategy
GCR	Geological Conservation Review site
GES	Good Ecological Status
GHT	Gloucester Harbour Trustees
GIS	Geographic Information System
HAT	Highest Astronomical Tide
HER	Historic Environment Record
HLT	High Level Target
HMWB	Heavily Modified Water Bodies
HRA	Habitats Regulations Assessment
HTL	Hold the Line
ICZM	Integrated Coastal Zone Management
IFCA	Integrated Flood Consequence Assessment
IROPI	Imperative Reasons of Over-riding Public Interest
JAC	Joint Advisory Committee (of the Severn Estuary Partnership)
KSG	Key Stakeholder Group, which acts as a focal point for discussion and consultation through development of the SMP
KWS	Key Wildlife Sites
LAT	Lowest Astronomical Tide
LDP	<i>Local Development Plan</i>
LPA	Local Planning Authority
MAFF	Ministry of Agriculture Fisheries and Food (now DEFRA)
MCZ	Marine Conservation Zone
MHWN	Mean High Water Neap tide
MHWS	Mean High Water Spring tide
MLWN	Mean Low Water Neap tide
MLWS	Mean Low Water Spring tide
MMO	Marine Management Organisation

Term	Definition
MoD	Ministry of Defence
MR	Managed Realignment
MSL	Mean Sea Level
MU	Management Unit
NAI	No Active Intervention
NE	Natural England
NEDS	National Economic Development Strategy
NFDCC	National Flood and Coastal Defence Database
NMR	National Monuments Record
NNR	National Nature Reserve
NT	National Trust
ODPM	Office of the Deputy Prime Minister
PCPA	Planning and Compulsory Purchase Act
PMG	Project Management Group
PPG	Planning Policy Guidance
PPS	Planning Policy Statement
PSA	Public Service Agreement
PU	Policy Unit
PPW	Planning Policy Wales
QRG	Quality Review Group
RBMP	River Basin Management Plan
RCZAS	Rapid Coastal Zone Assessment Survey
RDP	Rural Development Plan
RIGS	Regionally Important Geological Sites
RSS	Regional Spatial Strategy
RYA	Royal Yachting Association
SAC	Special Area of Conservation
SAM	Scheduled Ancient Monument

Term	Definition
SDAP	Sustainable Development Action Plan
SDS	Sustainable Development Schemes
SEA	Strategic Environmental Assessment
SECG	Severn Estuary Coastal Group = Client Steering Group (CSG)
SEP	Severn Estuary Partnership
SESMP2	Severn Estuary Shoreline Management Plan Review
SFC	Sea Fisheries Committee
SFRA	Strategic flood risk assessment
SMP	Shoreline Management Plan
SMP1	A first-round Shoreline Management Plan
SMP2	A second-round Shoreline Management Plan
SMR	Sites and Monuments Record
SoP	Standard of Protection
SPA	Special Protection Area
SRS	Single Regional Strategy
SSSI	Site of Special Scientific Interest
SuD _s	Sustainable Urban Drainage System
TAN	Technical Advice Note
UKCiP	United Kingdom Climate Impacts Programme
UKCP	UK Climate Projections
WAG	Welsh Assembly Government
WFD	Water Framework Directive
WPM	With Present Management
WSP	Wales Spatial Plan

Compliance to the SMP2 Quality Review Group (QRG) Terms of Reference

This Appendix of the SMP 2 seeks to meet the following requirements set out by the Terms of Reference (ToR) of the Quality Review Group:

- *Futurecoast has been used as the basis of the coastal process assessment, updated as appropriate with coastal monitoring data and any recent Coastal Management Strategies. The coastal processes in the area are sufficiently understood and uncertainty documented [including climate change – see Part A of this Report].*
- *National Flood and Coastal Defence Database (NFCDD) and/or up-to-date monitoring data has been used to assess the existing defence assets. Residual life is adequately addressed, high risk assets clearly identified and used in the NAI appraisal. See Part B of this Report.*
- *Baseline scenarios of No Active Intervention (NAI) and With Present Management practices have been appraised and predicted shoreline change mapped. Appraisals include consideration of climate change and discuss shoreline response (both in terms of how the shoreline will look and where it will be) for the three epochs. Any interactions and independencies along the coast have been considered. Assumptions made regarding defences are clear for each location under each epoch, e.g. timing of defence failure - see Part C of this Report.*
- *Where any mathematical models have been used, their purpose, assumptions made, and outputs are clearly reported. (no additional models used in this study)*
- *Key uncertainties, e.g. due to gaps in data, knowledge or modelling, are clearly set out in the plan and where appropriate sensitivity analysis has been undertaken to appraise the impact of uncertainties on policy decisions. (see SMP2 Action Plan)*

Purpose of the Report

This report is divided into two main parts as follows:

- PART A - An assessment of coastal processes and evolution;
- PART B - An assessment of existing coastal defences;
- PART C – An assessment of the NAI and WPM scenarios.

PART A (ABP Mer Ltd) is prepared to help improve the appreciation of coastal behaviour and dynamics that underpins the SMP2 development. In order to develop a sustainable management plan that identifies risks and defines implications of policy scenarios over different timescales there is a need to consider the natural morphological features and existing defences along the shoreline. This section constitutes the coastal morphological components of Task 2.1 as outlined in the SMP2 guidance documentation produced by Defra.

PART B (Atkins Ltd) details the condition of the defences along the SMP coast between Anchor Head and Lavernock Point. The data has been sourced from, the 1994 and 1997 MAFF coastal protection surveys, the previous SMP's and updated where possible using more recent data from NCFDD new surveys (Annex A) and the Severn FRM strategy. Local Authority engineers were contacted during the defence assessment process to confirm the distribution of defences and inform the SMP2 of additional defences (Annex B). Residual life is considered in broad-terms, looking at decadal time over 20, 50 and 100 years as guided by Defra (2006). In addition to present condition of the structure, estimates of residual life were reconsidered against the current state of the foreshore, general levels of exposure and the results of the assessment of coastal processes and evolution.

PART C (Atkins Ltd) details the two main baseline scenarios of No Active Intervention (NAI) and "With Present Management". It outlines the appraisal process adopted, the definitions of each baseline scenario and from this, attempts are made to map predicted shoreline change associated with each. The appraisals include consideration of climate change and discuss shoreline response (both in terms of how the shoreline will look and where it will be) for the three epochs (0-20; 20-50 and 50-100 years). Any interactions and discrete sections identified along the coast have been considered (in detail within Appendix G and H). Assumptions made regarding defences are clear for each location under each epoch, e.g. timing of defence failure.



PART A: Severn Estuary SMP2: Baseline Understanding of Coastal Behaviour and Dynamics

Date: May 2009

Project Ref: Error! Reference source not found.

Report No: R 1507

Atkins Ltd

Severn Estuary SMP2: Baseline Understanding of Coastal Behaviour and Dynamics

Date: May 2009
 Project Ref: Error! Reference source not found.
 Report No: R 1507

© ABP Marine Environmental Research Ltd

Version	Details of Change	Authorised By	Date
1	Draft	H Roberts	09.02.09
2	Final	A Williams	10.03.09
3	Final updated with external comments	H Roberts	08.05.09

Document Authorisation		Signature	Date
Project Manager:	H Roberts		
Quality Manager:	N J Frost		
Project Director:	A Williams		

ABP Marine Environmental Research Ltd
 Suite B, Waterside House
 Town Quay
 SOUTHAMPTON
 Hampshire
 SO14 2AQ

Tel: +44(0)23 8071 1840
Fax: +44(0)23 8071 1841
Web: www.abpmer.co.uk
Email: enquiries@abpmer.co.uk



PART A: Severn Estuary SMP2: Baseline Understanding of Coastal Behaviour and Dynamics

Contents

	Page
Error! Bookmark not defined.	
1. Introduction	7
1.1 Extent of the SMP	8
1.2 Structure of this Report	9
2. Estuary Description and Processes	11
2.1 Overview	11
2.2 Geology and Coastal Evolution	12
2.3 Geomorphology	14
2.4 Present Estuary Behaviour	16
2.5 Hydrodynamics	17
2.5.1 Tides and Currents	17
2.5.2 Wave Climate, Winds and Surges	19
2.5.3 Freshwater Flows	22
2.6 Sediment Transport	23
2.6.1 Sources	24
2.6.2 Pathways	25
2.6.3 Sinks/Stores	26
2.6.4 Sediment Budget	28
3. Process Units and Shoreline Change	29
3.1 PU1 Penarth	31
3.2 PU2 Cardiff Bay	31
3.3 PU3 Wentlooge	32
3.4 PU4 River Usk	33
3.5 PU5 Uskmouth	33
3.6 PU6 Caldicot Levels	34
3.7 PU7 The Severn Crossings	34
3.8 PU8 River Wye	35
3.9 PU9 Beachley to Lydney Point and Sharpness	35
3.10 PU10 Lydney Point to Tites Point (Sharpness to Purton)	36
3.11 PU11 Tites Point to Hock Cliff	36
3.12 PU12 Hock Cliff to Longney Pool	37
3.13 PU13 Longney Pool to The Weirs	38
3.14 PU14 The Weirs to Haw Bridge	38
3.15 PU15 New Passage to Portishead	38
3.16 PU16 River Avon	39
3.17 PU17 Portishead to Clevedon	39
3.18 PU18 Kingston Seymour	40
3.19 PU19 Middle Hope	40
3.20 PU20 Sand Bay	40
3.21 PU22 The Holms	41

4.	Assessment of Future Geomorphological Change	42
4.1	Climate Change	42
4.2	Future Geomorphological Change	42
4.2.1	Estuary-Wide Modelling of Future Change	43
5.	References/Bibliography	45

Tables

Table 1.	SMP extent in rivers and estuaries	8
Table 2.	Predicted return period values of significant wave height H_s for locations within the Severn Estuary	20
Table 3.	Predicted 100 year significant wave heights	21
Table 4.	Maximum surge heights in the outer Severn Estuary	21
Table 5.	Predicted return period water levels	21
Table 6.	Present day extreme water levels (mODN)	22
Table 7.	River flow characteristics	23
Table 8.	Suspended sediment yield of major tributaries of the Severn Estuary	24
Table 9.	Saltmarsh changes within the Proto CHaMP study area between 1946-8 and 2000	25
Table 10.	Summary of the Severn Estuary sediment budget	28
Table 11.	Mode of foreshore change	30
Table 12.	Current allowances for net sea level rise, South West and Wales	42

Figures

1. Severn Estuary SMP Boundary
- 2a. Location Map of the Severn Estuary (Inner)
- 2b. Location Map of the Severn Estuary (Middle)
- 2c. Location Map of the Severn Estuary (Outer)
3. Process Units and Strategic Flood Cells
4. Severn Estuary Conceptual Map of Coastal Processes
5. Bathymetry of the Severn Estuary
6. Tidal Range in the Severn Estuary as Measured Along the Shoreline
7. Spring Tidal Range at Avonmouth
8. Wind Rose from Avonmouth
9. Locations of 100 Year Significant Wave Height
10. Schematised Patterns of Sand Circulation
11. Schematised Circulation of Fine Sediment

1. Introduction

The aim of this report is to provide a review of coastal behaviour and dynamics based on the division of the estuarine shoreline into Process Units, as described for the first round SMP (Giffords 1998). The information contained within this report will then be used to develop the baseline scenarios (see Part C of this Report), identify risks and to test the response and implications of different management policy unit scenarios over the different timescales set for the second generation Severn Estuary SMP (SMP2). Ultimately, this information will help to determine the future management policies for the estuary. As well as considering natural features along the coast, this review will also consider the existing coastal defences, in terms of location, type and, in broad terms, residual life (see Part B of this Report).

Figure 1 shows the boundary of the SMP, Figures 2a-c provide more information on the location of the estuary. Figure 3 provides an outline of the process units and flood cells.

This report aims to present information in a logical and concise format, and to be accessible to a non-technical audience. As such, this review utilises high-level reports such as the first round SMP, Futurecoast, the Severn Estuary Coastal Habitat Management Plan (CHaMP), the Gwent Levels Foreshore Management Plan and the ongoing Severn Estuary Flood Risk Management Strategy (SEFRMS). In accordance with the SMP Guidance (Defra, 2006) this review does not aim to provide any new analyses, quantification or modelling related to the estuarine processes. In order to make the content as readable as possible to all stakeholders, the referencing to source material has been kept to a minimum and is focused mainly on reference to the above documents. However, all the documents used directly within the report are listed in Section 5.

This report includes:

- Review of existing reports and literature of the coastal behaviour and dynamics from the Severn Estuary First Generation SMP and other more recent coastal strategy studies;
- Review of existing data and reports of coastal behaviour and dynamics from the SEFRMS;
- A summary of the relevant information contained within Futurecoast;

This report should be read in conjunction with the Part B of this report which provides a summary of coastal defence information including the location, type and residual life (estimated time until the defence fails) of each defence length.

1.1 Extent of the SMP

The extent of the first round SMP was from Lavernock Point on the north (Welsh) side of the estuary upstream to the limit of the tidal influence at Gloucester and to Brean Down (south of Weston-super-Mare) on the southern (English) side of the estuary. The limit of the rivers and estuaries was taken to be the coastal protection limit.

The extent of the SMP was reviewed by the Severn Estuary Coastal Authorities Group and documented in the Severn Estuary Shoreline Management Plan Scoping Report (Severn Estuary Coastal Authorities Group, September 2008). The report concluded that the southern English boundary should be moved north to Anchor Head (north of Weston-super-Mare) to avoid breach potential and possible outflanking from the south of Brean Down. The new boundary would also provide a reasonable divide between the open-coast Bridgwater frontage of the North Devon and Somerset SMP Review and the Severn Estuary. This is illustrated in Figure 1.

The Scoping Report (Severn Estuary Coastal Authorities Group, September 2008) also concluded that the Severn SMP should be extended to include the estuaries up to their tidal limit rather than coast protection limit. Table 1 lists the rivers and estuaries that are included in the SMP review and their tidal limits as identified by the Scoping Report.

Table 1. SMP extent in rivers and estuaries

List of Inlets /Rivers	Part of Larger Estuarine System	Stated Tidal Limit	Grid Ref.
River Wye	n/a	Bigsweir Bridge	353869E 205104N
River Usk	n/a	Newbridge on Usk	338563E 194729N
River Rhymney	n/a	Weir	320874E 179879N
River Taff (via the Cardiff Bay Barrage)	Cardiff Bay	Cardiff Bay Barrage	319130E 172660N
River Ely (via the Cardiff Bay Barrage)	Cardiff Bay	Cardiff Bay Barrage	319130E 172660N
Ebbw River	n/a	Refuse Tip	330452E 185695N
Goldcliff Pill	n/a	Fisher's Gout	336709E 183024N
River Banwell	n/a	New Bow Sluice	335309E 166018N
River Yeo	n/a	Tutshill Ear	338152E 165835N
Blind Yeo	n/a	Blind Yeo Pumping Station	339221E 170223N
River Avon	n/a	Netham Weir	361609E 172600N
Oldbury Pill	n/a	Oldbury Pill Sluice	360274E 190673N
Berkeley Pill	n/a	Berkeley Pill Sluice	366665E 199892N
West Channel	River Severn	Maisemore Bridge	381696E 221222N
East Channel	River Severn	Llanthony Weir	382199E 218217N

Figure 1 shows the Severn Estuary boundary for the purposes of this SMP review.

1.2 Structure of Part A

Section 2 introduces the Severn Estuary as a system and then provides summaries of the geology, geomorphology, present estuarine behaviour, the hydrodynamics, including tides and currents, the wave climate, surges and extreme water levels, freshwater flows, and the sediment transport within the estuary.

Section 2 and 3 are supported by a conceptual map of the estuary supporting the following descriptions and illustrating the key physical control and linkage features within the SMP2 area. For example, sediment sources/sinks and pathways, sediment transport pathways (rates and nearshore transport potential), erosion and accretion rates, wave climate and areas at risk from overtopping. This map is limited to baseline processes, and does not include predictions of future change (Figure 4).

Section 3 provides a description of each of the units within the SMP as defined in the first round SMP, and a review of their historical change, utilising information from Futurecoast (Defra, 2002), where applicable.

Section 4 presents an assessment of future change in the Severn Estuary including an introduction to the most up to date predictions of climate change; and analysis of future geomorphological change within the estuary, using predictions from Futurecoast (Defra, 2002), as well as those from the CHaMP (ABPmer, 2006) and more recently updated for the SEFRMS (ongoing, ABPmer & Atkins).

1.3 Assumptions and Limitations

There is no single dataset that provides a detailed and up to date description of the seabed bathymetry for the Severn Estuary. This is a significant limitation.

Existing Admiralty Charts are commonly only updated where there is an interest to report safe depths in areas used for navigation and when new surveys are provided to UKHO.

The intertidal and shallow areas across sandbanks are surveyed on an infrequent basis and in places this data has not been resurveyed since 1938.

Admiralty Charts do not extend much further upstream than Sharpness which is the furthest port upstream in the estuary.

Geological and geomorphological information (e.g. sediment type and depth to rock head) in areas upstream of The Shoots remains incomplete and hence represents a key missing dataset for this SMP2.

The number of wave measurement sites within the Severn Estuary is very small relative to the amount of water level and flow data. The primary dataset was collected to support earlier barrage studies during the period 1978 to 1981 and using surface mounted wave recorders.

There is a lack of routine monitoring at any strategic level which offers quantification of rates of change in morphological features across the estuary. This is a significant issue for this SMP2 in terms of being able to attempt any type of shoreline evolution quantification which has presented itself as a key challenge for this project.

2. Estuary Description and Processes

2.1 Overview

The information presented within Section 2 is adapted from the following 4 main reports:

- ABPmer. 2006. Severn Estuary Coastal Habitat Management Plan. ABP Marine Environmental Research Ltd for Environment Agency.
- Atkins. 2004. Gwent Levels Foreshore Management Plan. Phase III final Report. Environment Agency Wales, AK4065.500/DG08
- Defra. 2002. Futurecoast. Produced by Halcrow, on behalf of Defra, 3 CD-Roms.
- ABPmer and HR Wallingford (2008) Severn Tidal Power – Scoping Topic Scoping Topic Paper – Hydraulics and Geomorphology, Study for DECC (2008)

Reference to “ongoing ABPmer & Atkins” refers to the Severn Estuary Flood Risk Management Study (SEFRMS) which is being prepared in parallel to the SMP2. No reports from that project are publically available at the time of writing. It should be noted that the Severn CHaMP (ABPmer 2006) only measured changes to the bathymetry of the estuary, all other descriptions of historical estuarine behaviour was sourced from other reports which are already referenced in the SMP2 review.

The Severn Estuary is the largest coastal plain type estuary in the UK, with the second largest tidal range in the world, at 10 to 12 m (Defra, 2002). The estuary extends from Haw Bridge to the north of Gloucester (Figure 2a) to its downstream limit of the estuary between the headland at Lavernock Point (Welsh coast) and Brean Down on the southern side of Weston Bay on the English coast (Figure 2c). The area to seaward is commonly referred to as the Inner Bristol Channel. It is at this location where the orientation of the coastline changes from a mainly east to west trend downstream to a north-east alignment and the start of the funnel-shaped estuary. The estuary extends from 15 km wide in its outer reaches to <60 m wide in the Severn near Gloucester. In most places it is less than 5 m deep, although the maximum depth of 30 m is in the principal channel between Flat Holm and Steep Holm at the seaward boundary of the SMP area (Figure 5). The tidal limit of the Severn is normally taken to be at Maisemore (West Parting) and Llanthony (West Parting) weirs, near Gloucester. However, on high spring tides the weirs can be overtopped by the tidal bore, and here the limit of the tidal flood risk is taken as the limit of the SMP, at Haw Bridge.

The Severn Estuary is a high-energy environment and a dynamic system that responds to the influence of tides and storms, which are events that can move large quantities of sediments and alter channel profiles and locations. The most significant threat (with the exception of major development) over the next 100 years is from

climate change and the response of the estuary to increases in sea level and storminess. The net effect of these issues is to create coastal squeeze along the developed/defended margins of the estuary, with the potential for loss of intertidal features (Defra, 2002).

The hydrodynamic character of the Severn Estuary is partly due to its form and partly due to its geographic setting. The form is determined from geological evolution, human intervention and interaction with present day physical processes resulting in a funnel shaped estuary. The main estuary channel is the former river channel, which became drowned and infilled as sea levels increased in the post-glacial period. The geographical setting of the estuary produces the very high tidal range that forms a major control on hydrodynamic processes.

The principal morphological components of the Severn Estuary are:

- Rocky intertidal platforms covered with a thin veneer of sediment;
- Major sand deposits and sandbanks in the central parts of the estuary;
- Subtidal channels, with gravel and sand or mud deposits;
- Muddy tributary estuaries;
- Muddy intertidal foreshores with relatively limited saltmarsh;
- Sand beaches and dunes on the Atlantic facing coast.

There are currently approximately 22,600 ha of intertidal habitat within the Severn Estuary (ongoing, ABPmer & Atkins). However, there is predicted to be a net loss of intertidal mudflats, sandflats and saltmarshes over the next 100 years. These losses are predicted to be unevenly distributed throughout the estuary with the greatest relative losses in the middle and outer estuary and gains within the inner estuary (ongoing, ABPmer & Atkins). This is driven by the predicted morphological and hydrodynamic changes within these sections of the estuary.

2.2 Geology and Coastal Evolution

The present configuration of the Bristol Channel and Severn Estuary as seen today has been formed during the Quaternary glacial and interglacial periods. The broad underlying geology in the outer estuary (i.e. to seaward of the Severn Crossings) is of folded and faulted lower Jurassic mudstones and limestones. Carboniferous limestone exposures occur at the headlands and the islands of Flat Holm and Steep Holm (Figure 2c). Further into the estuary, at Sharpness (Figure 2b), more resistant Silurian, Devonian and Cambrian strata transect the estuary and upstream of this point Jurassic and Triassic marls and sandstones underlie recent alluvial deposits. Bordering much of the estuarine deposits are Devonian and Carboniferous lithologies of Old Red Sandstone and limestones. Bedrock is evident in the cliff sections producing a rock-constrained system.

The Holocene started at the end of the last glaciation, at which time mean sea levels are believed to be around 30 m below present day levels. The estuarine environment would have been to the west (seaward) of its present location with a freshwater river valley where the inner estuary is today. Following deglaciation, available data

indicates an initial rapid rise in sea level of 25 m to around 6,000 years BP, which displaced the estuary landward into the river valley and resulted in sections of palaeochannels being infilled. Coastal plains were submerged and rocky headlands such as Brean Down were likely to be islands (Figure 2b). Since that time the size and shape of the Bristol Channel and Severn Estuary have varied with ongoing fluctuations in sea level. Subsequent rates of sea level rise to the present day were slower (approximately 1 mm/yr to 2,500 BP).

Prior to the rise in sea level the estuary was divided into two zones, one of bedload transport towards the sea, and one of transport inland. The rise in sea level caused the divide between the two zones to move up the estuary, in a landward direction. Sandy sediments were transported into the estuary to form the extensive banks now found along the original river channel axis, but the rise also released sediment from the seaward margin of the estuary into the Celtic Sea. The effect of rising sea levels has resulted in a wide expanse of exposed seabed without any major sediment cover, over an area extending from the Inner Bristol Channel into the lower reaches of the Severn Estuary, resulting in little sediment availability in this area. The present position of the bedload parting zone is now considered to be at the boundary between the Inner Bristol Channel and the Severn Estuary.

Lying directly on the underlying bedrock or earlier Pleistocene sediments of the Severn Estuary, at least four discrete sediment formations have been identified. With a thickness of 10-15 m, these deposits consist of alluvial and estuarine sediments and comprise much of the existing shoreline of the estuary. The earliest of these is the Wentlooge Formation, which first began accumulating between 3,000-2,500 years ago and ended at the start of the first Roman occupation about 2,000 years BP. Earth embankments were initially built during the Roman period and the marshes were drained for agriculture. This reclamation had the effect of narrowing the estuary and separating it from the natural fine sediment sink area. Three further formations: the Rumney (early Medieval to the 19th Century), the Awre (19th Century) and the Northwick (20th Century), are seen as steps or terraces across the intertidal zone.

Solid geological formations provide a set of hard constraints on the further evolution of the estuary. The boundary of the estuary with the Inner Bristol Channel is essentially a geological divide corresponding to a denuded spine of carboniferous limestone extending between the headland feature of Brean Down to the islands of Steep Holm and Flat Holm and across to Lavernock Point, which is a further headland formed of Lower Lias mudstones. The seabed at this location remains sediment poor with large areas of exposed rocky seabed. The location of the first Severn Bridge also represents a geological constraint bounded by Aust Cliff (Lower Lias) and Beachley Point (Keuper Marl), and with a series of rock platforms which direct the passage of the water. The Shoots, at the location of the Second Severn Crossing, is a further geologically constrained reach of the estuary, with an over-deepened channel. A further over-deepening occurs between Flat Holm and Steep Holm, where the channel passes between Flat and Steep Holm and out to the Inner Bristol Channel, and is frequently infilled with gravels.

Superficial sediments that rest on the top of the bedrock are glacial till, post-glacial valley infill, Flandrian accumulations and surface sediments, of which the surface sediments interact with waves and tides. The largest sediment accumulation in the estuary is the infilled river valley (in the area occupied by Middle Ground; Figure 2b) with sediment depths of up to 30m. However, unconsolidated sediment cover in the estuary is generally thin (typically less than 5m), and the total quantity of coarse sediment is small when compared with the tidal volumes, making this area relatively poor in coarse sediment. Sediments are also highly divided, leading to distinct and separate deposits of gravels, sands and muds, with areas of mixed sediments virtually absent.

2.3 Geomorphology

The Severn Estuary is the largest coastal plain type estuary in the UK. The tidal limit of the Severn is normally taken to be at Maisemore (West Parting) and Llanthony (West Parting) weirs, near Gloucester (Figure 2a). However, on high spring tides the weirs can be overtopped by the tidal bore. The predicted 1 in 100 year tidal flood risk area extends further upstream to Haw Bridge on the River Severn, the site which is regarded as the furthest upstream point where estuarine sediments have been identified.

The downstream limit is between the headland at Lavernock Point (Welsh coast) and Brean Down on the southern side of Weston Bay on the English coast (Figures 2c) and it is at this location where the orientation of the coastline changes from a mainly east to west trend downstream to a north-east alignment and the start of the funnel-shaped estuary. These changes in form have an effect on the local wave regime (reduced exposure to Atlantic swell) and tidal regime (through amplification of the tidal range). The estuary extends from 15 km wide in its outer reaches to <60 m wide in the Severn near Gloucester. In most places it is less than 5 m deep, although the maximum depth of 30 m is in the principal channel between Flat Holm and Steep Holm at the seaward boundary of the SMP area (Figure 5).

The funnel shape of the estuary is anchored by periodic bedrock promontories along the shoreline, including Hinkley Point and Lavernock Point at the western end of the study area, Redwick and Sudbrook at the Second Severn Crossing, Aust and Beachley at the Severn Road Bridge, and at Sharpness and Purton (Figure 2b). Each of these constriction zones serves as natural dividing points with respect to the dynamic processes operating within the estuary. Geomorphologically, the shape of the Severn Estuary is extremely significant as the increasingly narrow channel width serves to focus the incoming tidal wave, increasing its amplitude and creating high current velocities.

The western end of the estuary, open to the full extent of the Bristol Channel, which is in turn exposed to the Atlantic Ocean, is heavily influenced by wave processes. As the estuary narrows, the effects of wind waves lessen, and are superseded by the influence of tidal currents and river processes. The rocky headlands, such as Brean Down and Sand Point (Figure 2b), serve to modify wave and tidal processes,

disrupting littoral sediment transport and deflecting tidal currents in such a way as to favour deposition.

The margins of the estuary are dominated by wide intertidal mudflats and low-lying 'levels' (former floodplains), which would be inundated at high water in the absence of flood embankments, or by higher ground forming sea cliffs. The flood embankments currently artificially constrain the natural development of the estuary and prevent the floodplain from receiving sediment-laden water. Human activity has influenced the past evolution of the study area, particularly through reclamation, construction of flood banks, industrialisation and the planting of *Spartina*.

The other tributaries entering the estuary include the Rivers Frome, Cam, Avon, Yeo, Banwell, Brue and Axon on the English coast, the Ebbw, Wye, Usk and Rhymney on the Welsh coast, and the Taff and Ely that discharge into the Severn Estuary through Cardiff Bay.

The principal morphological components of the Severn Estuary are:

- Rocky intertidal platforms covered with a thin veneer of sediment;
- Major sand deposits and sandbanks in the central parts of the estuary;
- Subtidal channels, with gravel and sand or mud deposits;
- Muddy tributary estuaries;
- Muddy intertidal foreshores with relatively limited saltmarsh;
- Sand beaches and dunes on the Atlantic facing coast;
- Shingle beaches.

Habitat areas and predicted losses and gains were identified in the Severn CHaMP (ABPmer 2006). These figures have now been reviewed and updated as part of the SEFRMS (ABPmer and Atkins, ongoing (which were originally sourced from the CCW/Natural England Phase 1 Intertidal Survey). Although the SEFRMS does not cover the same extent as SMP2, which excludes Bridgewater Bay, the data have been used as it provides the best available data source. At the time of writing, permission is not granted by the EA to release these figures and hence are not included at this stage. To ascertain such information, readers are requested to contact the SEFRMS team at the Environment Agency).

There are large areas of rocky intertidal (about 1,500 ha) throughout the area, which are more predominant on the English side of the estuary. The types of rocky intertidal present include boulders, expanses of rock platforms, mussel/cobble scars and rocky pools. Rocky shores dominate the coastal zone in a number of areas, the most notable in the vicinity of the Second Severn Crossing, between Portishead and Sand Point, Lydney Cliff, Purton Passage and the outer Estuary. The sand deposits on Middle Grounds, Cardiff Grounds and Welsh Grounds, in the centre of the estuary, are generally mobile and can change location and nature over a range of timescales. Subtidal channels tend to remain stable, but within the channels there may be periodic formations of fluid mud layers or sand waves, depending on the local sediment regime.

The mudflats are extensive, comprising approximately 90% of the intertidal area (ongoing, ABPmer & Atkins) and are often found in association with the tributaries entering the Severn. Most of the muddy intertidal foreshores exhibit net erosion, although there may be seasonal variations, with accumulations and loss of material in response to changes in sediment supply and wave action.

Saltmarsh occupies approximately 7% of the intertidal area (ongoing ABPmer and Atkins). The sections of the estuary that support large extents of saltmarsh include the Wentlooge Levels, Caldicot Levels, Gwent Levels, the Severn Crossings, and into the inner reaches of the estuary. Areas of saltmarsh tend to accrete vertically in response to sea level rise and as a result of high sediment loads, but are prone to horizontal erosion because of the combined effects of strong tidal currents and wave action at the appropriate tidal height.

Shingle beaches are associated with many of the rocky intertidal areas, particularly on the English side, but also on both sides of the Second Severn Crossing. On the Welsh side there are scattered regions of shingle beaches interspersed amongst the rocky section of coastline near the outer estuary.

The key constraints to future morphological development are physical barriers such as flood embankments and non-erodible geological formations; and sediment availability, as well as the impacts of climate change.

2.4 Present Estuary Behaviour

The Severn Estuary is presumed to be under erosional pressure due to rising sea levels and as a major portion of the original natural intertidal area has been reclaimed over the past 2,000 years. Recent analysis has shown that both high and low water levels have moved landwards over much of the shoreline within the SMP area. The entire coastline downstream of Beachley appears to be marginally erosional, and exceptions to this are relatively rare. The most notable exception is in the vicinity of the River Usk at Newport, where there has been significant seaward movement of low water, but the system here is complex and an assessment of the sediment budget is difficult (Section 2.6). It is also true that the shoreline upriver of Beachley is more complex than the assumption of erosion throughout. The upper and outer areas of the estuary show a clear trend of net accretion over the past 100 years. The trend in the central estuary is less marked, although net erosion is evident.

For rock cliffs and platforms, there is a general understanding that erosion does occur, although at a slow rate and difficult to demonstrate discernable historical trend analysis over time. For example, a rate of 0.14 m/yr is reported for the cliffs between Lavernock and Penarth Head (Defra 2002). There are, however, exceptions, e.g. in Sand Bay (Worlebury Hill) slump erosion of 3.6 m/yr appears to be responsible for foreshore accretion (Defra 2002).

Horizontal erosion and accretion rates of marsh and associated mudflats are variable, ranging from erosion rates of 0.29 to 10.5 m/yr, with a mean of 2.13 ± 2.49 m/yr, to

accretion rates of 0.33 to 3.75 m/yr, with a mean of 1.66 ± 1.63 m/yr (ABPMer 2006). It is apparent that marshes and mudflats are eroding more commonly and at a faster rate than accretion is occurring. Marsh erosion in some places can be related to *Spartina anglica* planting and colonisation and subsequent dieback, i.e. there was a general trend of erosion before *Spartina* was introduced in the 1920s, which resulted in accretion. However, following this, dieback of the *Spartina* has resulted in a decrease in extent and has led to marsh edge erosion.

Whilst the marshes are being lost through edge erosion, the vertical accretion of the marshes has been accelerating. Whilst the reasons for this are not obvious, it may be that edge erosion and vertical accretion are related. With erosion, more sediment becomes available for deposition over the remaining, and gradually decreasing, marsh surface area.

The predominant long-term trend for mudflat behaviour is also one of erosion, although there is a paucity of data. There is evidence of mudflat lowering at Rumney Great Wharf and the Wentlooge Levels that has been estimated at 4.3 and 1.5 cm/yr, respectively. In other areas (Bridgwater Bay, Peterstone Flats and intertidal areas near the Newport Deep), net accretion is thought to be occurring. Core data from the mudflats of Bridgwater Bay indicate a deposition rate of about 0.5 cm/yr.

In general, areas within the estuary are now eroding, and this situation is likely to be exacerbated in the future by sea level rise.

2.5 Hydrodynamics

The hydrodynamic character of the Severn Estuary is partly due to its form and partly due to its geographic setting. The following section describes the forcing factors of the tides, waves, water levels and the resulting sediment transport within the estuary.

2.5.1 Tides and Currents

The Severn Estuary is subject to a strongly semi-diurnal and very large tide of 10 to 12 m, giving the estuary the second largest tidal range in the world (Figure 6). This high tidal range is due to the combination of the North Atlantic tidal wave approaching through the Bristol Channel and the further amplification and convergence of this tidal wave as it moves into the funnel-shape of the Severn Estuary. The tidal prism (i.e. the volume of water that enters and leaves the estuary on an average tide, calculated as the difference between the tidal volume at high water and that at low water) of the Severn Estuary has been calculated at approximately $96 \times 10^8 \text{ m}^3$.

The tide enters the Severn Estuary from the Bristol Channel as a progressive tidal wave with a fairly symmetrical sinusoidal shape. As the tide moves upstream it amplifies in range due to the funnel shape of the estuary, reaching a mean spring tidal range of 12.2m at Avonmouth and a maximum of 12.3 m on mean spring tides at Beachley (Chepstow, Severn Bridge) (Figure 7). Further upstream the estuary widens out slightly and shallows rapidly leading to increased asymmetry of the shape of the tidal curve and therefore steepening of the curve due to the shallow water effects (i.e.

the interaction of the tidal wave with the shallowing bed causes a slowing of the trough of the tidal wave with respect to the crest, therefore creating asymmetry) the flood tide becomes increasingly short and steep, whereas the ebb drops less steeply and more slowly (i.e. with a longer duration). For example, at Avonmouth the spring flood tide typically lasts about 5.5 hours compared to 7 hours of ebb flow (Figure 7). Eventually this steepening leads to formation of a tidal bore from Awre to Avonmouth on high spring tides, the size of which can reach 1.2m. Information on the tidal bore is explained further within Part C (Section 1.5) of this report.

Around low water there is a further feature of the tide: upstream of Oldbury Power Station low water levels on neap tides fall to marginally lower levels (0.1 m on average) than on spring tides. This is due to the longer times required to drain larger volumes of water on a spring tide, meaning that the system has not fully drained before the next flood tide commences.

The large and rapid rise and fall of the tide leads to very strong currents through the main body of the estuary. These strong currents maintain deep channels and high suspended sediment loads. Flows also increase in strength where they are forced through constrained narrows (e.g. The Shoots, just below the Second Severn Crossing, where the currents are in excess of 6 m/s). Where the tide becomes asymmetric then a dominance is established between ebb and flood currents: i.e. the flood tide becomes dominant in strength over the ebb (flood currents increasingly exceed those occurring on the ebb tide), but the duration of the ebb tide is longer. This effect also increases further up the estuary. These currents appear to be the primary mechanism for sorting seabed materials, so that the channels tend to contain gravels, with rocky patches, and the intertidal margins of the estuary have muddy deposits. Within the centre of the estuary there is also a large sand body called Middle Grounds, which extends to the north east into Welsh Grounds (Figure 2b). The estuary is considered to be ebb dominant towards the mouth, whilst further upstream the estuary is flood dominant. The location of the switch is just upstream of Avonmouth, which relates to a change in the bathymetry from deep water at the mouth to the shallow water of the upper estuary, although the position will vary as a function of factors including tidal range, fluvial flows and topography.

The direction of the currents is strongly influenced by the morphology of the seabed with currents generally aligned through the main channels and past shallow sandbanks. However, geological hard points extend out into the estuary and can influence the tidal flows to produce local modifications to the flow regime; for example, The Shoots directs the ebb tide over to the English shoreline upstream of Avonmouth.

At the confluences of the main tributaries there can also be impacts on the estuary flow as the tidal stream is influenced by flooding or ebbing tide within the tributary, which also leads to a dynamic local morphology in the tributary mouths. Typically the influence of freshwater discharges into the estuary from tributaries is negligible because under most conditions the tidal prism dominates. However, under high fluvial discharges, the relative significance of peak discharge is likely to become more locally significant with the potential to introduce large amounts of sediment. The currents created by the incoming tide travels up the estuary until the opposing fluvial flow

creates an area of slack flow, the location and timing of which varies with each tide. As the current is slowed and then stops altogether, deposition of both incoming and fluvial sediment can be expected. The tidal asymmetry results in a division of the sediment transport between mud and sand.

Marine sands are pushed up the estuary during the fast flowing flood tide where it is deposited at the point where slack water is reached. The slower flowing ebb tide is unable to remobilise all the material for a seaward return and therefore sand is transported up the estuary by a process called 'tidal pumping'. The landward direction of net sand transport has been confirmed by sediment trends analysis. Muds appear to remain in suspension for most tides and tend to be introduced into the estuary from fluvial sources.

In response to climate change there is likely to be an increase in mean sea level, which will modify the tidal dynamics and the shallow water interactions, by increasing the tidal wavelength leading to the potential for changes in the tidal range.

2.5.2 Wave Climate, Winds and Surges

The wave climate within the Severn Estuary is considered to be mainly wind-generated, with exposure to Atlantic swell waves limited by the change in orientation of the estuary around Flat Holm and Steep Holm (approximately at the western-most boundary of the SMP) (Figures 1 and 2). The wave conditions are linked to exposure to the direction of prevailing winds and fetch distances. At high water wave fetches can extend over long distances, whereas at low water the intertidal banks dramatically reduce fetches. Sand Bay and Weston Bay are the limit of the Atlantic facing beaches exposed to swell waves (Figure 2c).

Swell waves enter the Bristol Channel from the Atlantic Ocean, their height tending to decline in their passage up the estuary. As the alignment changes to the northeast at the boundary of the SMP area, the coast becomes increasingly protected from the incoming swell, and wind generated waves become more important. Because of the large tidal range, the Severn Estuary constantly changes as intertidal banks and wide intertidal flats become inundated and exposed, thereby changing the fetch distances over which waves can be generated. Upstream of Avonmouth, as the estuary narrows and fetches distances decrease, the size of waves also declines.

Inshore significant wave heights have been modelled for Hinkley, Berrow and Clevedon (ongoing, ABPmer & Atkins). No sites were selected on the Wales coast as part of the SEFRMS study. Table 2 shows that the predicted wave climate is the most severe at Berrow and this is to be expected since it directly faces the dominant westerly wave direction. Hinkley is more exposed and therefore more severe than Clevedon, owing to its position on the outer edge of the Severn Estuary, but its orientation, along with its location within a small embayment upstream of Hinkley Point will result in a less severe predicted wave climate at Hinkley than at Berrow.

NB: This Appendix does not undertake any new work and only reports on existing research, hence the existing research details the relevant information at locations listed in the following text only and hence reported in the tables.

Table 2. Predicted return period values of significant wave height H_s for locations within the Severn Estuary

Return Period	Clevedon H_s (m)	Berrow H_s (m)	Hinkley H_s (m)
1	1.63	2.71	2.14
2	1.79	2.94	2.32
5	2.01	3.24	2.58
10	2.18	3.47	2.77
20	2.35	3.70	2.96
50	2.58	4.01	3.22
100	2.76	4.24	3.41
200	2.94	4.48	3.61
500	3.18	4.80	3.87
1000	3.37	5.04	4.07

(Source: Ongoing, ABPmer & Atkins)

Future changes to the wave climate are likely to be in response to changes in storminess and in relation to the frequency and intensity of events. As part of the modelling carried out for the CHaMP (ABPmer, 2006), a wave energetics assessment was carried out to assess future changes to the wave climate as a result of climate change. The presence of various banks in the estuary influences the wave climate, since they act as natural breakwaters through shallow water friction and limit the fetch distance (at certain tidal stages) across which waves can be generated. The main wind direction is from the south-westerly and north-easterly with the maximum wind speed related to south-westerly winds (Figure 8). However, storms tend to be from one direction, typically approaching from the south-west. Wind waves can be generated anywhere within the estuary, but their size is dependent on the fetch distance across which the wind blows to enable wave generation. It is evident from the shape of the Severn Estuary that the fetch associated with the dominant wind direction would be long enough to generate big waves in the estuary.

The effect of future sea level rise upon locally generated wind waves will be to increase the wave-generating capacity of the fetches, and as a consequence, the heights of locally generated waves will increase at an inshore site as a result of sea level. Recent research concluded that on the Welsh coast significant wave heights will increase with sea level rise (ABP Research, 2000). Predicted increases in maximum significant wave height over the next 75 years are given in Table 3 (ABP Research, 2000), with locations shown in Figure 9. The analysis concluded that there is considerable uncertainty in predictions of future wave climate, although an exaggerated change in wave height of 0.5 m has a limited impact on the morphological response of intertidal profiles in comparison to that of the predicted rise in sea level.

Table 3. Predicted 100 year significant wave heights

Site Name	100 Year Significant Wave Height (H_s , m)
A1 Uskmouth	2.64
A2 Gold Cliff	2.12
A3 Magor Pill	1.70
A4 Sudbrook	1.95
A5 Mathern Pill	1.35
B1 Peterstone Gout	2.10
B2 Rumney River Outfall	2.03
B3 Queen Alexandra Dock	2.17

(Source: ABP Research, 2000)

2.5.2.1 Extreme water level predictions

Variations in water levels in the estuary are primarily determined by tidal forces with further short-term variations resulting from meteorological effects, such as surges, as well as long-term trends in mean sea level. Towards the tidal limit of the estuary, freshwater inputs from the rivers also have some influence.

Surges within the Severn Estuary have been measured at Avonmouth, with the largest occurring on March 16 1947, measuring 3.54 m. The average of the seven largest surges at Avonmouth between 1930 and 1954 was 2.51 ± 0.58 m. The effects of surges increase up-estuary in response to the funnel shape and the fetch distances available. Maximum surge heights in the outer Severn Estuary are shown in Table 4.

Table 4. Maximum surge heights in the outer Severn Estuary

Location	1 in 100 year Return Period Surge Height	1 in 200 Year Return Period Surge Height
Cardiff	1.61	1.67
Newport	1.86	1.89
Avonmouth	1.78	1.81

(Source: Environment Agency, 2005)

Recent predictions of extreme water levels have been made for locations within the Severn (Table 5), for the SEFRMS study area, up to and including Sharpness. The analysis draws on and updates information reported in previous Environment Agency funded studies referred to as the Gwent Levels Joint Probability Study (ABPmer, 2000) and Avonmouth to Aust Joint Probability Study (ABPmer, 2005), and provides additional joint probability analyses for sites along the frontage between Hinkley Point and Clevedon.

Table 5. Predicted return period water levels

Return Period (years)	Hinkley Point Extreme Water Level (m ODN)	Avonmouth Extreme Water Level (m ODN)	Sharpness Extreme Water Level (m ODN)
0.2	6.90	7.93	8.78
0.5	7.03	8.14	9.00
1	7.13	8.27	9.15
2	7.23	8.40	9.29

Return Period (years)	Hinkley Point Extreme Water Level (m ODN)	Avonmouth Extreme Water Level (m ODN)	Sharpness Extreme Water Level (m ODN)
5	7.36	8.55	9.45
10	7.45	8.65	9.56
20	7.55	8.75	9.67
50	7.67	8.87	9.80
100	7.76	8.95	9.89
200	7.86	9.03	9.98
500	7.98	9.13	10.09
1000	8.07	9.21	10.17

(Source: Atkins and ABPmer, 2009)

For the ongoing SEFRMS, extreme water levels as a result of the combination of tidal and fluvial extremes have been calculated for a series of points along the Estuary using joint probability analysis (Table 6). These have been reproduced below and more detail can be found in the Baseline Flood Consequence Assessment produced as part of the SEFRMS (not publicly available at time of writing this report). The location of the flood cells are summarised with the process units in Figures 3 and 4. Predicted extreme return period water levels will need to be increased to account for future anticipated sea level rise.

Table 6. Present day extreme water levels (mODN)

Return Period (years)	Strategic Flood Cell 1				Strategic Flood Cell 2				Strategic Flood Cells 7-8			
	JPA1	JPA2	JPA3	JPA4	JPA5	JPA6	JPA7	JPA8	JPA11	JPA12	JPA13	JPA14
1	8.05	7.99	7.92	7.93	8.1	8.59	8.54	8.56	8.57	8.38	8.29	8.27
5	8.28	8.25	8.20	8.18	8.34	8.81	8.75	8.75	8.85	8.65	8.57	8.55
10	8.83	8.35	8.29	8.29	8.43	8.89	8.84	8.83	8.96	8.77	8.68	8.65
20	8.45	8.43	8.39	8.40	8.52	8.99	8.93	8.91	9.07	8.85	8.78	8.75
50	8.55	8.54	8.52	8.55	8.65	9.11	9.02	9.03	9.18	8.97	8.90	8.87
100	8.62	8.61	8.60	8.63	8.76	9.18	9.13	9.12	9.27	9.06	8.98	8.95
200	8.70	8.73	8.68	8.76	8.85	9.28	9.23	9.19	9.36	9.14	9.06	9.03
1000	8.93	8.99	8.95	9.01	9.10	9.47	9.49	9.37	9.54	9.36	9.22	9.21

(Source: Ongoing, ABPmer & Atkins)

2.5.3 Freshwater Flows

There is relatively little information available regarding river flow into the Severn Estuary. The data that is available is sparse and often on a more regional scale than for specific waterways. It is generally accepted that the Severn Estuary is well-mixed, and that tidal forces dominate over the fluvial inputs. The river flow information presented in the Table 7 has been taken from the National River Flow Archive. Due to the low-lying topography of much of the hinterland, drainage of freshwater and discharge into the Severn is an important management intervention.

Table 7. River flow characteristics

River		Catchment Area (km ²)	Mean Flow 2001 (cumecs)	Mean Flow Pre-2001 (cumecs)
Rhymney		178.7	6.170	5.650
Usk		911.7	25.51	28.36
Wye		4010.0	84.14	74.06
Frome	Feed the Avon	148.9	1.817	1.720
Boyd		47.9	0.588	0.564
Chew		129.5	1.633	1.166
Parrett		74.8	1.273	1.204
N.B. The measurements are recorded at upstream gauging stations.				

(Source: National River Flow Archive)

The following is an attempt to synthesize the available data and information pertaining to sediment budget related issues (including known coastal erosion and accretion rates).

2.6 Sediment Transport

Sediment transport in the Severn Estuary is primarily controlled by the strong tidal currents. In general and especially in the upper Estuary, there is dominant upstream transport of sands and muds driven by the flood tide, although the potential also exists for downstream transport from the inner Severn Estuary, driven by high fluvial discharges and high ebb currents. In general, sediment sources are thought to be greater than the sinks, but there is a limited contemporary supply of sediment, which is likely to be linked to the recorded erosion on much of the estuary shoreline. There is little sediment data available upstream of the Shoots.

Within the centre of the estuary there are large accumulations of sand in the form of sandbanks and the action of the tidal currents has led to a sorting of sand with the median grain size on sandbanks tending to reduce with distance upstream. Within the estuary sand tends to be driven upstream by the influence of stronger flood tide currents compared to the ebb tide currents and there is estimated to be in excess of two billion tonnes of well-sorted sand in the sandbank and flats of the Severn Estuary.

Large volumes of sediment are carried in suspension (approximately 10M tonnes), and there are large amounts (approximately 30M tonnes on a spring tide, reducing to approximately 4M tonnes on a neap tide) of potentially mobile mud in the intertidal and subtidal areas. These high concentrations held in suspension throughout the estuary, are prevented from accumulating permanently by the strong tidal currents. There is a large variation between the amount of suspended sediment that can be maintained in suspension during spring tide periods, in comparison with that during neap tides, and leads to the formation of mobile suspensions of muddy material (fluid mud) in the deepest parts of the estuary. Typically fluid mud forms as the tide range falls towards the neap tide period and is then re-entrained as the tidal range increases towards the spring tide period. The fluid mud layers form rapidly to a depth of several metres in Bristol Deep and Newport Deep.

There is a strong correlation between tidal range and tidally averaged suspended sediment concentrations. At the seaward end of the Severn Estuary there appears to

be little seasonal influence on the relationship, although further upstream average concentrations in the summer months are lower. This is likely to be in response to the influence of seasonal discharge from the tributaries and the effects of wave action over the intertidal areas. During the summer months the intertidal areas may typically accumulate muddy material which is then removed during periods of greater wave action (i.e. winter storms).

2.6.1 Sources

2.6.1.1 Fluvial sources

The main contemporary sources for new sediments entering the system are the silt input from the tributaries, estimated at 1 million tonnes per year. The largest contributors are the Wye Avon, Usk and Severn (Table 8).

Table 8. Suspended sediment yield of major tributaries of the Severn Estuary

Rivers	Sediment Yields (Tonnes/yr)
River Usk	41,733
River Avon	53,060
River Wye	262,883
River Severn	347,227

(Source: Brooks, 1974)

2.6.1.2 Cliff erosion

Some fine sediment is contributed by limestone and shale cliff recession, on the margins of the Bristol Channel and the Severn Estuary. The contribution from cliff recession in the Severn Estuary varies between a rate of 0.06 and 1.3M tonnes/yr, although the total sediment input into the estuary has been estimated at 0.3M tonnes/yr, with 0.2M tonnes/yr of mud, 0.05M tonnes/yr of sand and 0.05M tonnes/yr of gravel (Gifford *et al.*, 1998).

2.6.1.3 Saltmarsh erosion

Marsh erosion represents a very small proportion of the total annual cohesive sediment supply into the estuary (approximately 0.1M tonnes/yr). However, on average the saltmarsh edge has retreated by around 1 m/yr, corresponding to 2-3 km of recession since Roman times. Recorded historic changes in saltmarsh were analysed in detail for the North Wessex Proto CHaMP (for the south side of the estuary only) (Royal Haskoning, 2004). According to this study the English side of the Severn has experienced a loss of 21% of the saltmarsh surface between 1946-8 and 2000 (Table 9).

Table 9. Saltmarsh changes within the Proto CHaMP study area between 1946-8 and 2000

Geomorphological Unit	Area (Ha)		Change	
	1946-8	2000	Ha	%
Severn Estuary	443.5	348.2	-95.3	-21
Bridgwater Bay	112.0	69.3	-42.7	-38

(Source: Royal Haskoning, 2004)

Detailed analysis of saltmarsh change along the Gwent Levels has described changes in saltmarsh coverage from aerial photographs and OS Maps (Atkins, 2004), however, this is not quantified as an overall change in area. An estimated 44,400 tonnes/yr of sediment is supplied through erosion of saltmarshes along the Gwent Levels (Atkins, 2004) which is in general agreement with 0.1M tonnes/yr quoted for the entire estuary by the Severn Tidal Power Group (STPG 1989).

2.6.1.4 Mudflat erosion

There is a long-term trend of erosion of the intertidal mudflats, which is estimated at 2.5M tonnes per year.

2.6.1.5 Subtidal erosion

Erosion of the bedrock is low and does not provide a major source of sediment input to the estuary. The subtidal mud deposits off Bridgwater Bay and around Peterstone Flats and Newport Deep are potential sources of sediments, but their overall contribution is low, and not thought to exceed 0.5M tonnes/yr.

2.6.1.6 Bristol Channel input

Although the inner Bristol Channel and Severn Estuary are considered to be tidally flood dominant, the total amount of fine sediment entering the system from seaward is insignificant compared to the total fluvial sediment supply. However, sand are supplied from the area to the west and the estuarine sand probably largely represents ice-introduced material reworked eastward post-glacially from the Celtic Sea and Bristol Channel.

2.6.2 Pathways

The supply of mud and sand to the system and their transport paths within it are complex and not clearly understood. The sediment flux of coarse sediments between the Inner Bristol Channel and the Severn Estuary is small, due to the area of exposed bedrock which has little sediment to supply across a wide bedload parting zone. For this reason the estuary is frequently described as a closed system. However, it has been suggested that during south-westerly storms there is a mechanism for transport

which can drive sediments from seaward across the bedload parting zone and into the estuary.

2.6.2.1 Sand transport pathways

From available evidence it appears that sand moves eastward into the Severn Estuary. Along this route the various banks form local recirculation cells, and some sand may return westward along the southern sand zone (Figure 10).

2.6.2.2 Fine sediment transport pathways

The movement of fine sediment is complicated by the presence of high concentrations of suspended sediment in the water column. Mud deposits in Bridgwater Bay are thought to move along the estuary, mainly on the English side, to form the turbid water mass. Further sediment transport patterns include a down-estuary transport from Newport to Barry, with up-estuary transport dominant in other parts of the estuary (Figure 11).

2.6.3 Sinks/Stores

The main active sink for muddy material in the estuary is Newport Deep and the subtidal area fronting Bridgwater Bay. There is not a significant supply of fine sediment from the Bristol Channel, and the present maintenance dredging of fine sediments within the estuary does not lead to any significant removal of fines from the estuary.

2.6.3.1 Saltmarsh accretion

The intertidal saltmarshes have historically been subject to extensive land claim, thereby diminishing their capacity to act as a sink for cohesive sediments. Landward recession of the marsh edge is currently taking place; however, many saltmarsh surfaces are experiencing vertical accretion. Examples include the marshes at Pill House and Brean and between Steart and Hinkley, around Bridgwater Bay. These marshes are reported to have accreted 0.06M tonnes/yr between 1962 and 1964 (ABPmer, 2006).

2.6.3.2 Mudflat accretion

In some areas mudflats are erosional, and in other parts accretional. Mudflats in Bridgwater Bay, Peterstone Flats and Newport Deep are characterised by an accretion rate of between 1 and 2M tonnes/yr. Variation in mudflat behaviour can be attributed to the fluvial flows, and mud transport is more significantly associated with the tributaries of the Severn Estuary. The mixing of freshwater and seawater encourages local deposition in some intertidal areas, whereas in the central regions of the Severn Estuary the tidal flows are generally strong enough to prevent significant deposition

(Gifford *et al.*, 1998). Due to the spatial variability in the behaviour of the mudflats, it is not possible to quantify the contribution of these elements as a sink.

2.6.3.3 Subtidal deposition

Within the study area mudflat deposition has been identified within an area at the mouth of the River Usk and the inner Severn Estuary. It is not possible to quantify the contemporary sediment volume of seabed deposition for Bridgwater Bay or the Severn Estuary as a whole.

2.6.3.4 Suspended sediment

There is believed to be a long residence time for material within the study area, with little gain or loss from the system. Suspended sediment concentrations within the estuary are very large and increase upstream to peak around Sharpness on spring tides. Estimates of spring tide suspended sediment concentrations vary from 13M tonnes to 30M tonnes within the estuary, and an estimate on a neap tide was 4M to 9M tonnes (ABPmer, 2006). This suspended load is thought to be at a capacity level, i.e. the amount is relatively constant and no more sediment can be added into the system without either being lost to the Atlantic Ocean or becoming deposited.

Suspended sediment concentrations vary significantly and have been measured at >250 mg/l to <10,000 mg/l in the Severn Estuary, with a vertical concentration gradient responding to semi-diurnal and spring-neap cycles. The lack of a primary sink due to historic reclamation is thought to be part of the reason for high sediment concentrations in the estuary (ABPmer, 2006).

2.6.4 Anthropogenic activities

The current anthropogenic activities that have the potential to affect sediment transport within the Severn Estuary are dredging for navigation and for aggregate extraction.

Ports undertake routine maintenance dredging at the ports of Bristol, Cardiff, Newport and Sharpness, and material is disposed of either at licensed pumped discharges or deposited at licensed spoil grounds. Such activities do not represent a net loss of sediment to the system, but rather a recycling of sediment within the system, but they do amend the sediment budgets and morphology locally (CHaMP, 2005).

Approximately 1.5M tonnes of aggregate are landed at the Severn Estuary ports annually, although this includes sediment sourced from Nash Bank and Holm Sand, both of which are in the Bristol Channel. Numerous studies have been undertaken to assess the possible effects of aggregate extraction on coastal processes, but to date no effects have been proven (CHaMP, 2005). Whilst the dredging activities affect the sand bank morphology locally and also create sediment plumes, the scale of the effects is considered to be within the high degree of natural variability within the system.

2.6.5 Sediment Budget

Table 10 presents a summary of the current understanding of the sediment budget of the Severn Estuary, and each element has been quantified where possible. From Table 10 it appears that the sediments in the estuary appear to be in a state of constant reworking and recycling with only relatively minor losses and additions of new sediments. It is important to understand that these figures have been collated from a range of data sources over a range of different timescales and as such are subject to considerable error; nevertheless it represents the best available data for quantifying the sediment budget within the SMP2 study area.

It is difficult to fully quantify the sediment budget for the Severn Estuary, as some elements of the budget cannot be quantified based on available information. Therefore it is not possible to conclude with certainty if the budget is in balance, or if the Severn Estuary is a net exporter or importer of sediment. However, the review suggests that the sources are greater than the sinks and the volume of sediments held in the water column is very high. Therefore it is likely the estuary is a net exporter of sediment (ABPmer, 2006).

Table 10. Summary of the Severn Estuary sediment budget









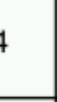
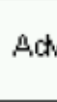

Dynamic Status	Element	Description	Rate or Sediment Load	Total
Sources	Rivers	Fluvial sediment supply	1M tonnes/yr	4.16M to 5.4M tonnes/yr
	Cliff	Erosion	0.06 to 1.3M tonnes/yr	
	Saltmarsh	Erosion (horizontal)	0.1M tonnes/yr	
	Mudflat	Erosion	2.5M tonnes/yr	
	Subtidal	Erosion	0.5M tonnes/yr	
Sinks ¹	Saltmarsh (around Bridgwater Bay)	Accretion (vertical)	0.06M tonnes/yr	1.06 to 2.06M tonnes/yr
	Mudflat (Bridgwater Bay, Peterstone Flat and Newport Deep)	Accretion	1 to 2M tonnes/yr	
Transfers	Water Body	Suspended sediment	Estimates vary from 9-13 tonnes (neap to spring) and 30M tonnes (spring)	30M tonnes
	Anthropogenic Intervention	Aggregate extraction	1.5M tonnes/yr	1.5M tonnes/yr
¹ Sinks estimate is referring to localised areas, the rate of accretion in some areas has not been quantified.				

3. Process Units and Shoreline Change

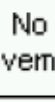
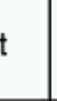
This section refers to Process Units as defined for the first Severn Estuary SMP (Figure 3) (Gifford *et al.*, 1998). Analysis undertaken for Futurecoast on change in shoreline position is included, where shoreline change is demarked by the cliff line or the mean high water mark or mean low water mark. For each unit considered to be open coast within Futurecoast (i.e. up to and including the Severn Crossings) an overview of historical shoreline change is presented in the form of a 'mode of foreshore change', using the information presented in Table 11.

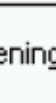
Throughout this section north bank refers to the left bank when looking upstream (Welsh bank) throughout the following description whilst south bank refers to the right bank (English bank) when looking upstream.

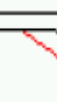
Table 11. Mode of foreshore change

Mode	MHW	MLW	Intertidal	Profile Change
+6	Advance	Advance	Flattening	
+5	Advance	Advance	No rotation	
+4	Advance	Advance	Steepening	
+3	Advance	No movement	Steepening	
+2	Advance	Retreat	Steepening	
+1	No Movement	Advance	Flattening	
0	No movement	No movement	No rotation	MHW  MLW
-1	No Movement	Retreat	Steepening	
-2	Retreat	Advance	Flattening	
-3	Retreat	No movement	Flattening	
-4	Retreat	Retreat	Flattening	
-5	Retreat	Retreat	No rotation	
-6	Retreat	Retreat	Steepening	

(Source: Defra, 2002)

3.1 PU1 Penarth

The Penarth unit extends from Lavernock Point (the southern boundary of the SMP on the Welsh side) in the south to the southern end of the Cardiff Bay Barrage. Most of the east facing unit has a soft cliff coastline of Triassic mudstone, with the exception of the low-lying frontage at Penarth Esplanade. There are extensive areas of intertidal rock exposures fronting Ranny Bay (in the south) and Penarth Head (in the north), and there is a wave-cut rock platform, which is partially covered by beach sediments (shingle) in the vicinity of Penarth Pier. Beach material is predominantly derived from cliff erosion. The sedimentary environment consists of a boulder strewn foreshore with limestone and maerl cliffs that weather rapidly. Offshore sediment transport is considered to be in dynamic equilibrium and an anticlockwise circulatory transport around Cardiff Grounds (approximately 3 km offshore). The predominant transported sediment size is fine to medium sand (0.25 mm – 0.35 mm). The Cardiff Grounds spoil site is two miles east of Penarth Head.

The Penarth frontage is generally sheltered from ocean waves due to its orientation, although Lavernock Point is exposed to waves propagating up the Bristol Channel. The dominant wave directions for the unit are 60° to 120°. Predicted tidal residuals show an ebb dominated process along the inshore area.

There is evidence of low rates of cliff line retreat and erosion of the shingle beach. Due to the extensive areas of intertidal rock exposures at Ranny Bay there is little evidence of significant change on this coastline over the last 100 years. Stakeholders are reporting cliff erosion of the coastal path in the area which seems to be of local concern. Further north and adjacent to Penarth Head, there is some evidence of cliff-line retreat at rates of 0.14 m/yr. The cliffs supply sediment to the toe, providing protection and sediment to the unit. Over the last 100 years evidence suggests the low water mark has moved landward, narrowing the foreshore and increasing vulnerability to extreme waves and water levels.

Futurecoast Summary

There is evidence of some cliff retreat with foreshore steepening and retreat. Some beaches have dropped in height. Mode of foreshore change at Lower Penarth: +1 (Table 11).

3.2 PU2 Cardiff Bay

The Cardiff Bay unit extends from Penarth Head in the south to Cardiff Flats in the north, covering the Cardiff Bay Barrage. The unit historically included a drowned tidal inlet of the Rivers Taff and Ely backed by the Cardiff Levels, but much of the present frontage and hinterland stands on reclaimed land. The south-east facing embayment was impounded by the Cardiff Bay Barrage (completed in 1999), constructed across the mouth of the bay between Queen Alexander Dock and Penarth Head. Prior to the barrage construction, the Bay had a large expanse of tidal mudflats, with some saltmarsh on the nearshore. The Taff and Ely rivers that discharge into the Bay are now non-tidal, influencing the deposition of sediment within the Bay.

The barrage impounds water within the Bay as a recreational amenity feature though it is also a flood defence structure which can be closed to prevent high tides in the

estuary entering the Bay. The barrage is predicted to remain in place until 2108 (ongoing, ABPmer & Atkins) with minimal maintenance.

Futurecoast Summary

Major changes have resulted from extensive port development, reclamation and infilling. Mode of foreshore change at west Cardiff: -6 (Table 11).

3.3 PU3 Wentlooge

The Wentlooge Unit extends from Cardiff Flats in the south to the western bank of the River Usk in the north. The majority of the unit is low-lying, with the exception of the area between Cardiff Flats and Pengam Moors to the south of Cardiff (and the mouth of the River Rhymney). The unit has a low-lying foreshore composed of muddy Holocene marine and estuarine alluvium covering relatively wide intertidal mudflats, extending up to 1.6 km offshore.

Predicted tidal residuals for the Wentlooge Levels show an ebb-dominance, with the majority of current vectors directed onshore.

Along all sections of this unit the position of MLW has retreated and the intertidal zone narrowed. There is also evidence of foreshore lowering. Analysis of OS maps and aerial photographs shows that the saltmarsh along this frontage reduced in area between 1887 and 1946 (Atkins, 2004). A program of *Spartina* planting in the 1950s caused the saltmarsh to expand in area between OS surveys of 1946 and 1971 at Peterstone Great Wharf but Rumney Great Wharf still continued to erode (Atkins, 2004). Surveys from 1971 and 1994 show that saltmarsh along this frontage eroded further between these dates, this was followed by some accretion at Peterstone Great Wharf and erosion at Rumney Great Wharf between 1994 and 1999 (Atkins, 2004).

The cross-sectional profiles at Wentlooge and Rumney show a narrow and relatively steep upper saltmarsh. The top of the saltmarsh is approximately 1.5 m below mean high water and confirms the lowering of the upper zone levels downstream. There is some indication that at Rumney the tidal flat has been lowered by approximately 3 m over the last 70 years (Gifford *et al.*, 1998), confirming that the area is undergoing significant erosion. Analysis of available data suggests an overall lowering of 4.3 cm/yr of the intertidal mudflats in the vicinity of Rumney Great Wharf between 1926 and 1997 and 1.3 – 1.8 cm/yr between 1965 and 2002 at a similar location (Atkins, 2004).

Sections of the foreshore are undergoing accretion (i.e. Peterstone Great Wharf) and others erosion (i.e. Rumney Great Wharf). Revetments have been placed along certain sections, stabilising the shoreline. Analysis of OS maps has shown spatially varying rates of change: south of Rumney Great Wharf eroding at 2.1 m/yr; north of Rumney Great Wharf eroding at 1.3 m/yr; and Peterstone Great Wharf accreting at 0.4 m/yr.

Futurecoast Summary

Rumney Great Wharf has been undergoing mudflat erosion since 1886 (60 to 205 m retreat of MHW) and Peterstone Great Wharf accreting (130 to 210 m extension of MHW). The coastline is stable between Peterstone Gout and West Usk Lighthouse, though there has been slight localised landward movement of MLW. Between the lighthouse and the River Usk the saltmarsh is accreting at the northern end and eroding at the southern end. Mode of foreshore change at the Wentlooge Levels: -6 (Table 11).

3.4 PU4 River Usk

The River Usk unit extends from the mouth of the Usk between the Wentlooge Levels and Newport Docks at the confluence with the Ebbw, to the tidal limit at Newbridge-on-Usk. The River Usk is a meandering tidal river channel through Devonian sandstone and mudstone. The river is flanked by extensively developed land and open spaces with flood protection. There is also a dredged navigation channel into Newport Docks. Through Newport the channel is fairly canalised and generally there have been limited changes due to the bank protection. The upstream reaches north of Newport follow a meandering course. The tidal dynamics of the Usk behave in a similar manner to that in the Severn Estuary, with little modification. The high tidal range ensures that there are strong tidal currents.

The strong tidal currents of the Usk erode and transport large quantities of fine sediment during spring tides, but during neap tides much of this sediment is deposited on the bed, forming very soft or fluid mud deposits, to be remobilised on the next spring tides. This unit is generally characterised by no net erosion or deposition of cohesive sediments. In the lower reaches of the estuary there are areas of both locally accreting and locally eroding saltmarsh.

3.5 PU5 Uskmouth

The Uskmouth unit extends from Uskmouth Power Station at the mouth of the Usk in the west to Gold Cliff in the east. The eastern boundary marks the transition from low-lying alluvium to the Jurassic Lias cliffs at Gold Cliff. The unit is at the western end of the Caldicot Levels, and therefore has a low-lying backshore, fronted by wide intertidal mudflats. The area consists of wet reedbeds, wet grasslands and shallow saline lagoons. The intertidal area is essentially an extension of the muddy foreshore at the mouth of the Usk.

The tidal dynamics of this unit behave in a similar manner to that in the Severn Estuary, with little modification. The predicted tidal results along the inshore of the Caldicot Levels unit are directed upstream.

The line of the estuary mouth has changed little, and in the past has been largely maintained by maintenance dredging. The western section of this unit is eroding and the eastern is accreting. There are saltmarsh areas along much of the shoreline, particularly between the Nash Breakwater and Goldcliff Pill, which has suffered significant localised erosion and accretion over the last 100 years. The construction of the Cardiff Bay Barrage and the loss of the SSSI led to a mitigation scheme, the Gwent

Wetlands Reserve, being constructed along the frontage of Uskmouth, Saltmarsh and Gold Cliff.

Futurecoast Summary

At Uskmouth the shoreline has retreated between 75 and 135 m in the last 100 years, whilst further to the east there has been accretion at MHW, 130 m at Salt Marsh Reen and 230 m at Goldcliff Pill. There has been extensive erosion at Gold Cliff and groynes have been constructed. Mode of foreshore change at the Gold Cliff frontage: +1 (Table 11).

3.6 PU6 Caldicot Levels

This unit extends from the rocky outcrop at the Gold Cliff promontory in the south west to the southern side of Sudbrook Point in the north-east, where there is a transition from the low-lying alluvial plain of the Caldicot Levels to the Old Red Sandstone headland at Sudbrook. The unit is a south-east facing, low-lying foreshore composed of muddy Holocene marine and estuarine alluvium, fronted by a relatively wide intertidal expanse of saltmarsh and sandbanks. The backshore is almost entirely below the level of mean high water springs and is therefore defended by a continuous clay embankment located on former marsh surfaces, typically reinforced by a wall and revetment. Predicted tidal residuals show a downstream, onshore directed current, although to the north of Gold Cliff residuals are directed offshore.

There has been long-term retreat and erosion of saltmarsh in the past, although the rates do vary. The saltmarsh located north of Magor Pill, extending to Caldicot Pill has been subject to a long term erosional trend and retreat of the mean high water mark by up to 140 m (between West Pill and Caldicot Pill) and up to 170 m adjacent to Rogiet Moor Pill/West Pill), since the 1880s. However, to the south west of Magor Pill MHW has not changed significantly. There has also been erosion of the intertidal zone below that of the marsh. Some increase of saltmarsh area between 1946 and 1998 along this frontage can be explained by the planting of *Spartina* in the area (Atkins, 2004).

Futurecoast Summary

Between Gold Cliff and Cold Harbour Pill, there has been movement of MHW, although near Cold Harbour Pill there has been extensive movement to seaward of MLW. To the east erosion dominates; at Caldicot Pill, where the intertidal width has remained constant, MHW and MLW have been subject to recession. Mode of foreshore change at Redwick (centre of frontage): +6, and at Caldicot Pill: -6 (Table 11).

3.7 PU7 The Severn Crossings

This unit includes both banks of the Severn, from Sudbrook Point to Beachley on the north bank, and from New Passage to Aust Rock on the south bank; and relates to the constriction of the estuary between the promontories on each side. There are rock exposures offshore, notably the English Stones and the estuary is restricted to a single navigable channel; The Shoots. The Shoots has locally scoured depths in excess of 10 m and an area with extensive drying banks. Around the Severn bridges the river is obstructed by rocks, which create high turbulence through the tide. The tide divides at Beachley Point, with one branch flowing into the River Wye and the other flowing

upstream. Current velocities can reach 3 m/s, although the strength and direction of the tide is greatly affected by the submergence of banks and rock areas, as well as freshwater flows from the rivers. There is little or no slack water in the main channels and the tide may run in opposing directions as the tide turns.

Both shorelines include extensive areas of low-lying land. On the north (Welsh) bank the Sudbrook headland comprises low sandstone cliffs and the Second Severn Crossing structures. To the north it is low-lying with saltmarsh and intertidal mudflats, with headlands at Black Rock and Beachley. The intertidal flats at Mathern Oaze have remained stable or have increased in area over the last 100 years, and the shoreline has also remained stable with only local or small scale changes. The Beachley headland comprises hard rock outcrops and low marl cliffs.

On the southern (English) bank, the stretch between New Passage and Aust Warth is low-lying and is defended with grassed embankments. There is saltmarsh on the foreshore and intertidal zone, generally with a shallow slope, and the higher saltmarsh clearly shows the former surfaces of the Northwick and Rumney formations. The stretch from Littleton Warth to Aust Warth, including Aust Cliff, is located on higher ground. The mudflat area of Northwick Oaze is relatively stable, although there has been accretion at Aust and Beachley (between 20 and 60 m at the latter since the 1880s).

Futurecoast Summary

The cliffs and rock platform are resistant to erosion. There has been a slight seaward movement of MHW at Mathern Oaze, with changes to MLW. There has been saltmarsh accretion to the east of the River Wye (north bank) of 20 to 60 m. at Northwick Oaze the shoreline has been stable and at Aust Warth both MHW and MLW have migrated seawards. Mode of foreshore change at Mathern: +1; and at Aust: +4 (Table 11).

3.8 PU8 River Wye

This unit extends from the mouth of the River Wye to Bigsweir Bridge, the tidal limit. The river flows through predominantly carboniferous limestone geology with Triassic sandstone outcropping at the upstream limit and at the mouth. The Wye is constrained over much of its length by high ground and narrow floodplains. The meander bends are constrained by bedrock and have changed little over the last 100 years. There are localised mudflat margins. There has been little change to the river form due to the influences of bedrock and weirs.

Futurecoast Summary

No coverage.

3.9 PU9 Beachley to Lydney Point and Sharpness

This unit includes both banks of the Severn. On the north bank the unit extends from Beachley to Lydney Point, and on the south bank from Littleton Warth to Sharpness Docks. The unit lies between the two constrictions in the width of the estuary at Beachley/Aust and Lydney/Sharpness. The coast is characterised by coastal outcrops

of hard geology, cliffs and intertidal rock exposures. Both banks have extensive areas of low-lying land behind, except for the cliff line between Beachley and Pillhouse Rocks.

Offshore there are large intertidal sand banks (e.g. Beacon Sands) and rock exposures with influence the low tide channel. The tidal range here is reduced and the tidal wave becomes more asymmetric.

Movement of the coastline is linked to the sand bars and channel behaviour occurring at different timescales to the estuary sequence of erosion and accretion. Recent erosion has been noted at Cone Pill (8.2 m/yr since 1989); Lydney defences and Cone Pill to Guscar Rocks (resulting from bank slippages, in turn due to landward translation of the secondary low water channel and the increasing curvature of the channel meander).

Futurecoast Summary

No coverage.

3.10 PU10 Lydney Point to Tites Point (Sharpness to Purton)

This unit includes both banks of the Severn, from Lydney Point to Wellhouse Rock on the north bank and from Sharpness Docks to Cotterday Hole (Tites Point) on the south bank. There is a significant reduction in the width of the estuary between Sharpness and Tites Point and this area can be referred to as a rock controlled basin. The tides within this unit are characterised by a tidal wave that has a shorter flood period compared to that of the ebb. The tide also becomes more asymmetric with distance upstream.

The shorelines on both banks of the process unit have been fairly stable for the last 100 years. There is low-lying land at Purton, to the west of Tites Point which is defended, although the most of the rest of the unit is bordered by higher ground. The unit comprises mainly Devonian mudstone cliffs with outcrops of Jurassic mudstone cliffs at the northern end of the unit (Purton and Cotterday Hole). There are intertidal sand banks present. There has been little movement in the shoreline, and the only evidence is some small scale accretion and erosion on the Sharpness Bank in the last 100 years.

Futurecoast Summary

No coverage.

3.11 PU11 Tites Point to Hock Cliff

This unit includes both banks of the Severn, from Hagloe House to Awre on the north bank and from Tites Point to Hock Cliff on the south bank. Upstream of Tites Point there is a large increase in the width of the estuary and the upstream boundary of the unit relates to the transition from the more open estuary with long fetches to the meandering tidal river. The tide has a shorter flood period compared to that of the ebb.

The tidal range is also reduced and the tidal wave becomes more asymmetric with distance upstream.

There is historic evidence for variation in the location and extent of the offshore sand and mud banks and bars; however, the position of the high water mark has remained fairly stable within this reach although there are more changes on the south bank of the channel. There has also been some movement of MLW.

On the north bank there are some grassed embankments, although much of the land is above extreme tide level, there is low-lying land at the mouth of Bideford Brook and at the inside of the meander east of Awre; there has been little movement of MHW.

The entire south bank frontage is low-lying, and the area comprises recent estuarine alluvium backed by older estuarine alluvium. At the upstream end of the unit there is an extensive near and offshore area of mud. There are a series of warths along this bank. There is an accretional trend between Middle Point and Tites Point, whilst the mud bank adjacent to Frampton has either eroded or remained relatively stable.

Futurecoast Summary

No coverage.

3.12 PU12 Hock Cliff to Longney Pool

This unit includes both banks of the Severn, from Hayward to Cowley's Elm on the north bank, and from Hock Cliff to Longney Pool on the south bank. The upstream boundary of the unit relates to the transition from predominantly sandy shoals to finer sediments upstream. The tidal wave has a short but rapid flood and long ebb.

The outer parts of the meander have remained stable over the last 100 years, although there is erosion of the cliff at Newnham on the north bank. The inner parts of the meander have experienced a pattern of accretion and erosion with bars increasing in size as others decrease. The extent of movement is controlled by rocky outcrops. Banks at the downstream end show less change, though there is deposition at MHW. At Lower Dumball there is a tendency towards accretion of sediments, whereas Upper Dumball is stable. The stretch from Dumball to Rodley Bank fluctuates between accretion and erosion.

The south bank is characterised by low-lying alluvium and sedimentary depositional environments. At the upstream end of the unit there is potential for erosion on the outside bend of the river meander. At Longney Bend typically the banks have been eroding and the mudflats accreting.

Futurecoast Summary

No coverage.

3.13 PU13 Longney Pool to The Weirs

This unit includes both banks of the Severn, from Cowley's Elm to Maisemore on the north bank, and from Longney Pool to Llanthony Weir on the south bank. The upstream boundaries are the normal limit of tidal flows of the Severn, and the weirs prevent saline intrusion under normal conditions, although they are overtopped by high spring tides. The sediments within this unit are predominantly fine. The tidal wave has a very short but rapid flood and long ebb, and the tidal range reduces with distance upstream.

The low-lying ground is mainly estuarine alluvium. There is additional erosion control on the outside of the meander adjacent to the village of Elmore. Upstream from the Lower Parting the western channel is the main flood channel and the eastern is the navigation channel. The rural reaches up to the weirs are defended by earth bunds in poor condition. The channel is relatively stable in platform.

Futurecoast Summary

No coverage.

3.14 PU14 The Weirs to Haw Bridge

This unit includes both banks of the Severn, from Maisemore and Llanthony Weirs to Haw Bridge, which represents the upstream limit of the SMP. The western channel is the main flood channel and the east channel is the navigation channel through the city of Gloucester. This unit is essentially a fluvial reach with only infrequent tidal influence; however, it is included within the SMP due to process interactions between this unit and the estuary downstream of the weirs. There has been little change in the position of the channel.

Futurecoast Summary

No coverage.

3.15 PU15 New Passage to Portishead

This unit extends from New Passage in the north to the Old Pier at Portishead in the south, on the south bank of the Severn. The north-eastern boundary marks the transition from the low-lying saltmarsh shoreline of the Severn Crossings unit (PU7) to the offshore rocky exposures of English Stones. The south-western boundary marks a transition from the low-lying shoreline of Portbury Wharf to the cliffed coast of the Portishead to Clevedon unit (PU17). The unit is a north-west facing embayment, and the shoreline is generally fronted by intertidal mud, sand or gravel banks, saltmarsh and rock outcrops at the northern end. Between Chittering Warth and Old Passage there is a large gravel and sand bank at the mudflat edge. The River Avon is at the south-western end of the unit.

There has been marked accretion, for example, at Christening Wharf historic survey indicate 104 m of accretion, and at Chapel Pill there has been 100 to 160 m of accretion and a slight seaward extension of MLW. The channel of Avonmouth port is generally controlled by anthropogenic structures, although the wide intertidal area has

reduced from 0.8 km wide to 0.17 km, although the area behind the East Breakwater has continued to accrete.

Futurecoast Summary

Development at Avonmouth port has masked shoreline behaviour. Portbury Wharf has undergone accretion. The channel and port entrance is generally controlled by anthropogenic features. MHW has migrated seaward in the area to the south of Stup Pill and northward to Severn Beach. Mode of foreshore change at East Compton (northern end of Unit): +1; and at Stup Pill: +6 (Table 11).

3.16 PU16 River Avon

The River Avon unit extends from the mouth of the Avon to the Netham Weir upstream in Bristol, which is the normal tidal limit, although it is overtopped by high spring tides. The underlying geology varies upstream, as does the land use. There has been little natural morphological change in the outer estuary, although there has been a slight expansion of the marsh areas. However, there has been extensive reclamation and development at the mouth of the channel, which has constrained the estuary mouth, narrowing the tidal inlet.

Futurecoast Summary

No coverage.

3.17 PU17 Portishead to Clevedon

This unit extends from Portbury Docks in the north-east to Wains Hill in the south-west, and is characterised by cliffs fronted by a rock platform, forming a narrow intertidal area, covered by intermittent mud and gravel deposits. The north-eastern boundary marks the transition from the cliffed coast in this unit to the low-lying estuarine alluvium shoreline to the north. The south-western boundary marks the southern limit of the rocky cliffs and wave cut platform at Wains Hill. The tidal residuals show ebb-dominance. The cliffed coast is largely undefended, although some local protection is in place, and the cliffs have a hard rock geology which is resistant to erosion. Erosion rates do vary through the unit according to local geological and geomorphological factors, although they are generally low.

The northern part of the unit from the Old Pier in Portishead to Portishead Point is cliffed, with a wave cut platform. The cliffed areas are subject to slow erosion rates, although some cliff sections have specific geological conditions that contribute to higher erosion rates, such as the lack of a toe area.

Salthouse and Woodhill Bays are the only low-lying areas in the unit: Salthouse Bay was a muddy depositional environment, which was enclosed by the construction of a seawall; and Kilkenny and Woodhill Bays are fronted by saltmarsh which has accumulated to 130 m wide and the low water mark has also moved seaward in this area. Offshore from Clevedon a new sand bar is forming.

Futurecoast Summary

Erosion of the cliff section is low and temporally variable. Saltmarsh has accumulated in Kilkenny and Woodhill Bays, although the latter is currently eroding, particularly at mid-tide level, in conjunction with foreshore narrowing and steepening. Mode of foreshore change (from north to south along unit frontage) at Portishead: +4; at Weston-in-Compton: +1; and at Walton Park: +1 (Table 11).

3.18 PU18 Kingston Seymour

This unit extends from Wains Hill in the north to St Thomas's Head in the south. Wains Hill marks the transition from the cliffed coast to the north to the low-lying shoreline of estuarine alluvium to the south. There are resistant rock outcrops to the south-west and north-east. A number of tributaries discharge into this unit including (from north to south) the Blind Yeo that discharges into Clevedon Pill; Kingston Pill, the Congresbury Yeo River and the River Banwell.

The tides are ebb-dominant in this area. Some protection from wave and tide processes is afforded to the shoreline by offshore sand banks. This process unit comprises of low-lying land is defended along the entire frontage by a system of embankments, fronted by upper and lower saltmarsh of varying width and mudflats. Although foreshore accretion has been noted in the vicinity of Clevedon Pill (just to south of Wains Hill) which has accreted by up to 200 m since the 1880s, the general trend over the past 100 years is for erosion within much of the bay, with a net loss of saltmarsh. Rates of erosion of 0.4 to 1.1 m/yr have been measured along the frontage.

Futurecoast Summary

There is a general trend of erosion with a 40 to 100 m reduction in foreshore width since the 1880s. There has been variable saltmarsh accretion to the south of Wains Hill, with up to 200 m accretion over the last century. Mode of foreshore change at Treble House Farm: +6; and at Wick Warth: -6 (Table 11).

3.19 PU19 Middle Hope

This unit extends from St Thomas's Head to Sand Point and the boundaries are defined by the seaward limits of the carboniferous limestone headlands at each end. The unit has steep cliffs, and a narrow rocky intertidal area. The central section, Middle Hope, is a ridge that rises to a height of 43 m. To the rear of the ridge is low lying estuarine alluvium. The hard rock cliffs experience only a low rate of erosion and there are no coastal defences along this frontage. There is some evidence of narrowing of the foreshore within the central section especially of the muddy lower intertidal zone. This has been accompanied by steepening of the foreshore but this does not appear to have resulted in an increased rate of cliff erosion, due to the presence of the wave cut platform.

Futurecoast Summary

No coverage.

3.20 PU20 Sand Bay

This unit extends from Sand Point in the north to Birnbeck Island in the south. The headlands at each end of the Bay are composed of carboniferous limestone. The bay faces towards the west and has a large intertidal area of sandbanks and mudflats, which dries to a line between the headlands. Sand dunes form the backshore and part of the sea defence. There is also an area of saltmarsh at the northern end, with an intertidal rock platform. To the north of the headland to the south the rocky intertidal platform is covered by gravel and boulders. The tidal residuals within the Bay are thought to be flood dominated, forming part of an offshore anti-clockwise circulation. This unit is likely to be subject to significant wave action during storm events.

Low-lying land is defended by the wide beach and dune system. The Bay appears to have generally remained stable over the last 100 years with little movement of MHW and MLW, although there has been erosion at the southern end and accretion at the northern end (450 m over the last 100 years). A large beach renourishment scheme was undertaken in the 1980s, and parts of the dunes have been stabilised by artificial means.

Erosion at the southern end of the bay was due to wave attack on the cliff face, and there have been local cliff failures. Rock has been placed to protect the cliff at this location.

Futurecoast Summary

At Worlebury Hill (southern part of the Bay) MHW has migrated seawards, as a result of cliff failures. In the central bay, MHW and MLW have remained stable, with some evidence of beach lowering. At the northern end of the Bay, MHW has prograded by approximately 450 m since the 1880s. Mode of foreshore change at Sand Bay: -6 (Table 11).

3.21 PU22 The Holms

This process unit includes the two small islands of Flat Holm and Steep Holm, which are on the southern, downstream boundary of the SMP. Flat Holm has a shoreline of 2 km and rises to 26 m. Steep Holm is 4 km to the south of Flat Holm, has a shoreline of 2 km and rises to 72 m. Both islands are formed of carboniferous limestone and there is little recorded evidence of morphological change. The Holms are subject to very limited development.

Futurecoast Summary

No coverage.

4. Assessment of Future Geomorphological Change

This section presents the most up to date predictions of climate change for the Severn Estuary (Defra, 2006) and a summary of future geomorphological change using Futurecoast and the recent Severn Estuary modelling carried out for the CHaMP and the SEFRMS.

4.1 Climate Change

Climate change is predicted to lead to increased rates of sea level rise and a risk of increased storminess. The currently understood allowances for increases to mean sea level relevant to the Bristol Channel and Severn Estuary are summarised in Table 12.

Table 12. Current allowances for net sea level rise, south West and Wales

Assumed Vertical Land Movement (mm/yr)	Net Sea Level Rise (mm/yr)			
	1990 - 2025	2025 - 2055	2055 - 2085	2085 - 2115
-0.5	3.5	8.0	11.5	14.5

(Source: after Defra, 2006)

In relation to the potential for increased storminess Defra guidance suggests applying an indicative sensitivity range with an increase of 5% for the period 1990 to 2055 to offshore wind speed and extreme wave height, and then an increase of 10% for the period 2055 to 2115. For peak river flows (preferably for larger catchments) respective increase are 10% from 1990 to 2025 and then 20% from 2055 to 2115.

4.2 Future Geomorphological Change

As sea level rises, the future evolution of the estuary is predicted through examination of its Holocene evolution, in which the present form of the estuary is the result of the more or less continuous sea level rise since the last glaciation. Under this rising sea level regime, sand banks, mudflats and marshes have developed. When the rise is slow, high intertidal marshland is able to form; when it is fast, rollover takes place, when the existing shoreline sediments are eroded and wetlands are reduced in area to fringe marshes more associated with the low intertidal areas. As the estuary enlarges and continues its inland migration, new sediment released into the system from the erosion of pre-existing sediments may well become available for increased deposition and creation of habitats elsewhere. Conversely, as the estuary increases in area, the resultant increase in fetch lengths and tidal volumes may lessen the likelihood for new deposition to occur. There is also a possibility of increasing wave heights throughout the estuary. Future changes that can be expected from changes in storm intensity, frequency and track, and changes in the rate of sea level rise are:

- Erosion of the shoreline;
- Increased flooding occurrence; and
- Loss of intertidal width.

It is considered likely that continued vertical accretion of the tidal flats and marshes would be possible, enabling these areas to maintain their elevation with sea level rise,

but that marsh edge erosion would also occur and the foreshore would narrow throughout much of the estuary.

4.2.1 Estuary-Wide Modelling of Future Change

Modelling undertaken for the CHaMP (ABPmer, 2006) and since updated for the SEFRMS, predicted changes to the cross-sectional area and profile due to increases in sea level and changes in tidal range, using the previous Defra sea level rise prediction of 6 mm/yr (CHaMP) and the updated predictions, as shown in Table 12. It would be expected that the estuary response would be an increase in cross-sectional area and an associated widening and deepening of the channel. This is due to the predicted increase in mean sea level and hence tidal prism. Some areas would be influenced by physical constraints such as sub-littoral geology, underlying clay; bedrock or other hard substrata which can prevent the estuary from widening or deepening as well as the presence of sea defence walls, quay walls or other human developments. Long-term predictions must take these factors into account before any future morphological adjustments can be determined. Without the constraints in place the estuary continues to widen within the model, where in reality this would be prevented from happening by these physical constraints. The application of these physical barriers in the model is essential, particularly when considering issues such as coastal squeeze and estuary rollback.

The results from the CHaMP indicate that typically changes to the cross-section widths for the Severn Estuary are increases in the range of 100 to 300 m in the downstream areas, reducing to 10 to 20 m upstream. The change in width is limited both by the geology and the maximum water level, and smaller changes are expected upstream where the estuary is most constricted in terms of small intertidal areas constrained by fixed barriers, i.e. flood defence embankments. In general, the estuary also tends to deepen in response to sea level rise.

Predicted losses of intertidal area differ between the CHaMP and SEFRMS modelling results, mainly due to the different sea level rise predictions used; previous predictions were linear whereas the revised predictions represent an accelerating curve of the rate of sea level rise. In order to present the most up to date and relevant results, the changes to intertidal area presented are those from the SEFRMS, and are presented as percentage loss from the 2005 baseline (22,867 ha). The modelling was carried out over three time epochs, 2025, 2055 and 2105.

The results for 2025 show change in bed elevation at the upstream end of the Severn, whereas the rest of the estuary shows no significant change. The modelling predicts a loss of intertidal area in the future, increasing with the increasing rate of sea level rise. The predicted loss of intertidal area for the Severn Estuary by 2025 is approximately **3% of the baseline area**.

By the 50 year time epoch (2055), much of the estuary is predicted to experience a significant change in the bathymetry with a predicted loss of intertidal of **6% of the baseline area**. The largest change is predicted along the margins of the estuary, where sections are widening and deepening to accommodate the increased mean sea

level. The loss of intertidal area and the increase in mean depth will result in an increase in water elevations.

By 2105 a loss of **15% of the baseline intertidal area** is predicted. The loss of intertidal area is likely to lead to a significant change to the flow regime along the margins of the estuary, which is in turn likely to increase the risk of erosion of existing flood defences. Deeper bed elevations coupled with an increase in mean sea level increase the risk of larger wave heights.

5. References/Bibliography

Atkins and ABPmer. 2009. SFRMS Baseline Flood Consequence Report. Working Draft Report.

ABP Research. 2000. Gwent Levels Hydraulic Modelling Study, Objective A: Joint probability surge tide and wave analysis. ABP Research & Consultancy Ltd., Research Report No. R.818.

ABPmer. 2005. Avonmouth to Aust Tidal Defence Scheme: Joint Probability Analysis of Waves and Water Levels. Undertaken for WS Atkins on behalf of the Environment Agency. ABP Marine Environmental Research Ltd, Report No. R.1225.

ABPmer. 2006. Severn Estuary Coastal Habitat Management Plan. ABP Marine Environmental Research Ltd for Environment Agency.

Atkins. 2004. Gwent Levels Foreshore Management Plan. Phase III final Report. Environment Agency Wales, AK4065.500/DG08

Brooks, R.E. 1974. Suspended sediment and solute transport for rivers entering the Severn Estuary. PhD thesis, Bristol University.

Defra. 2002. Futurecoast. Produced by Halcrow, on behalf of Defra, 3 CD-ROMs.

Defra. 2006. Flood and coastal defence appraisal guidance FCDPAG3 economic appraisal. Supplementary note to operating authorities - climate change impacts. October 2006.

Environment Agency. 2005. Severn Estuary Coastal Habitat Management Plan (CHaMP): Phase 1 Report: Conceptual Understanding, Habitat Inventory and Habitat Behaviour Units. Report by Babbie Brown & Root, ABPmer and Royal Haskoning on behalf of Environment Agency, Midlands Region.

Gifford & Partners, GeoData Institute, ABP Research & Consultancy, Peter Fraenkel Maritime and Adams Henry. 1998. Severn Estuary Shoreline Management Plan.

Royal Haskoning. 2004. North Wessex Proto Coastal Habitat Management Plan (CHaMP). Produced on behalf of the Environment Agency and English Nature.

Severn Estuary Coastal Authorities Group. 2008. Severn Estuary Shoreline Management Plan Review Scoping Report. Produced by Severn Estuary Coastal Authorities Group

Figures

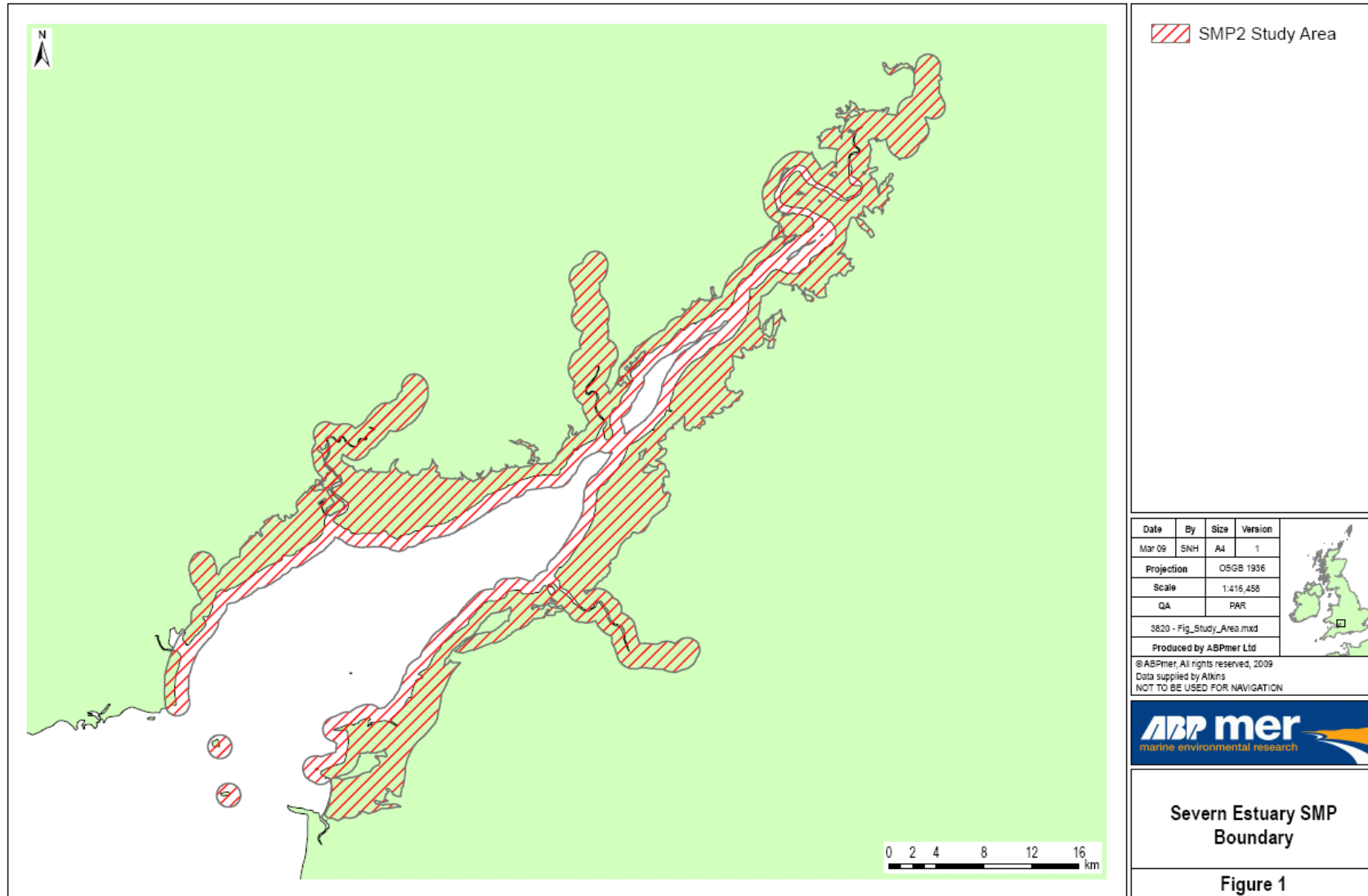

Severn Estuary SMP2 - Appendix C - Baseline Understanding of Coastal Behaviour, Dynamics and Coastal Defences

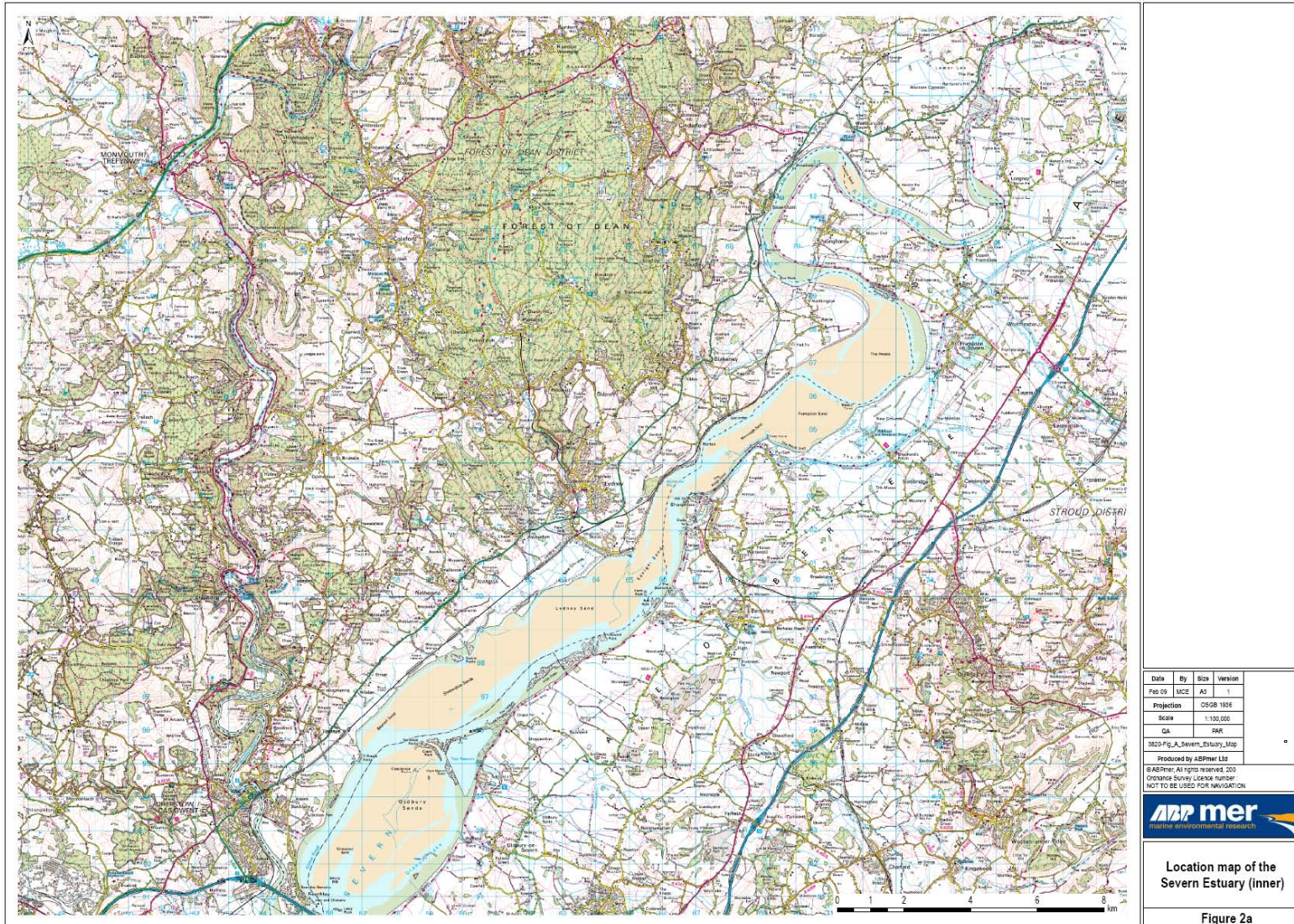

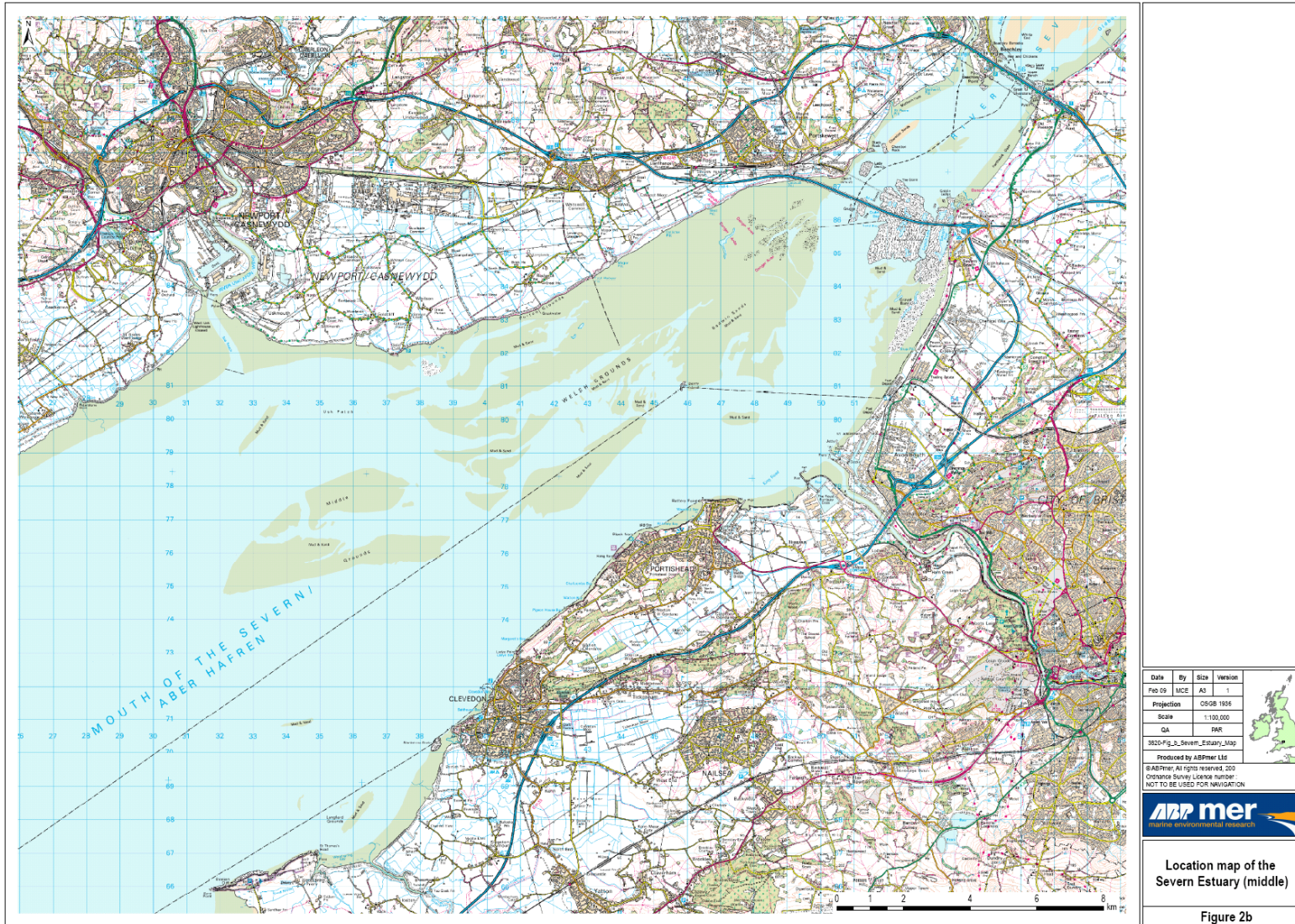



Severn Estuary SMP2 - Appendix C - Baseline Understanding of Coastal Behaviour, Dynamics and Coastal Defences

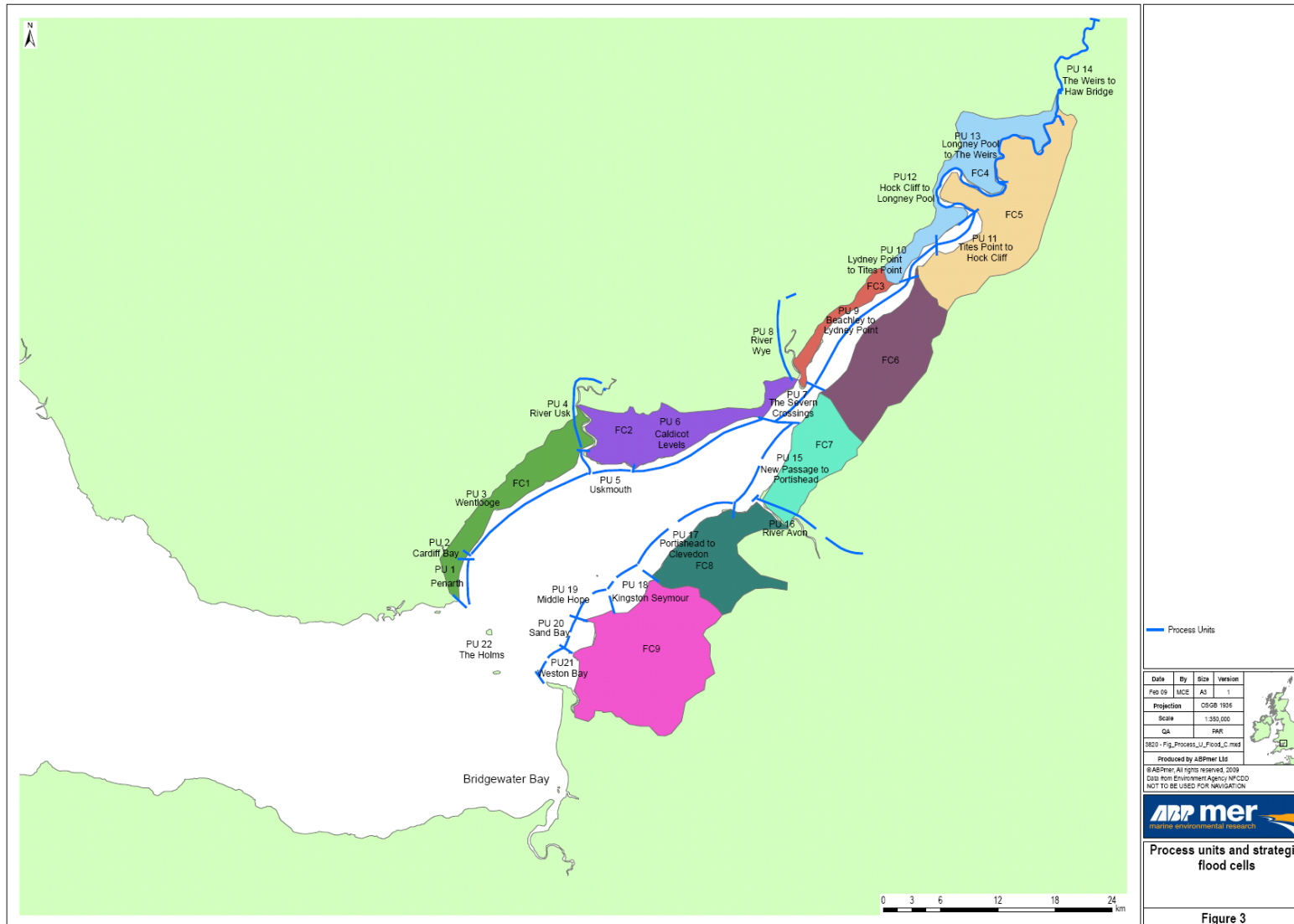

Severn Estuary SMP2 - Appendix C - Baseline Understanding of Coastal Behaviour, Dynamics and Coastal Defences

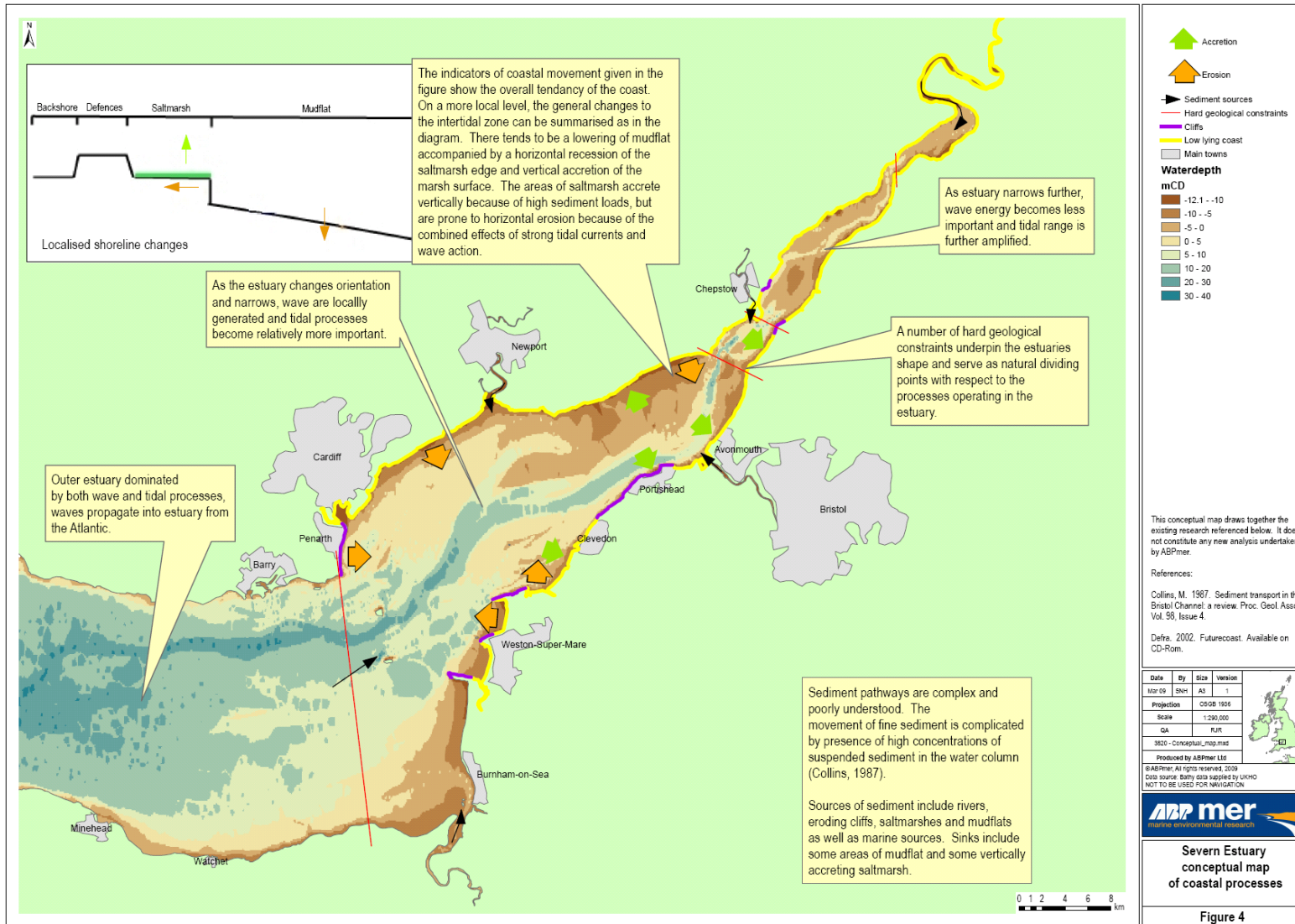

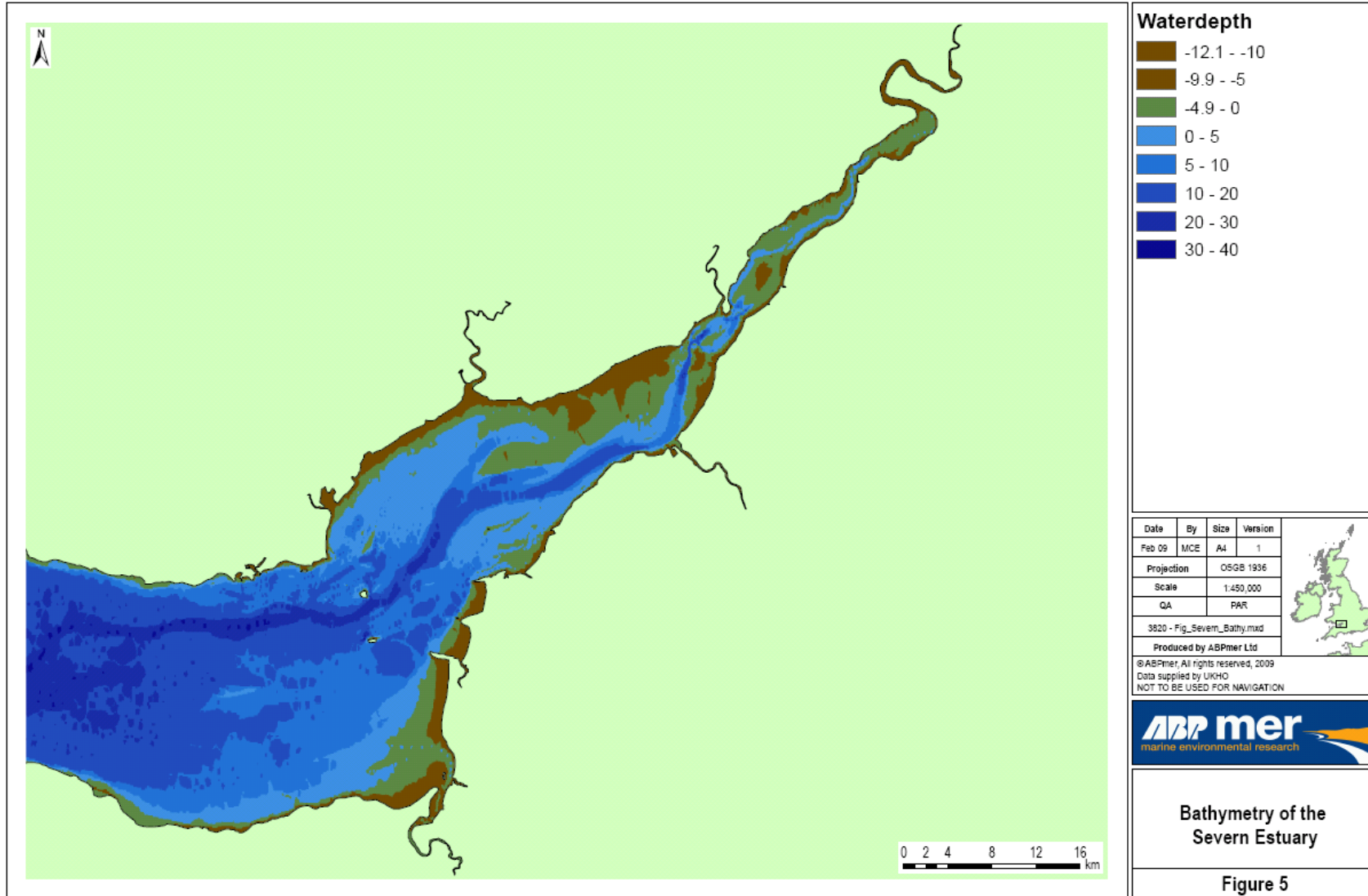

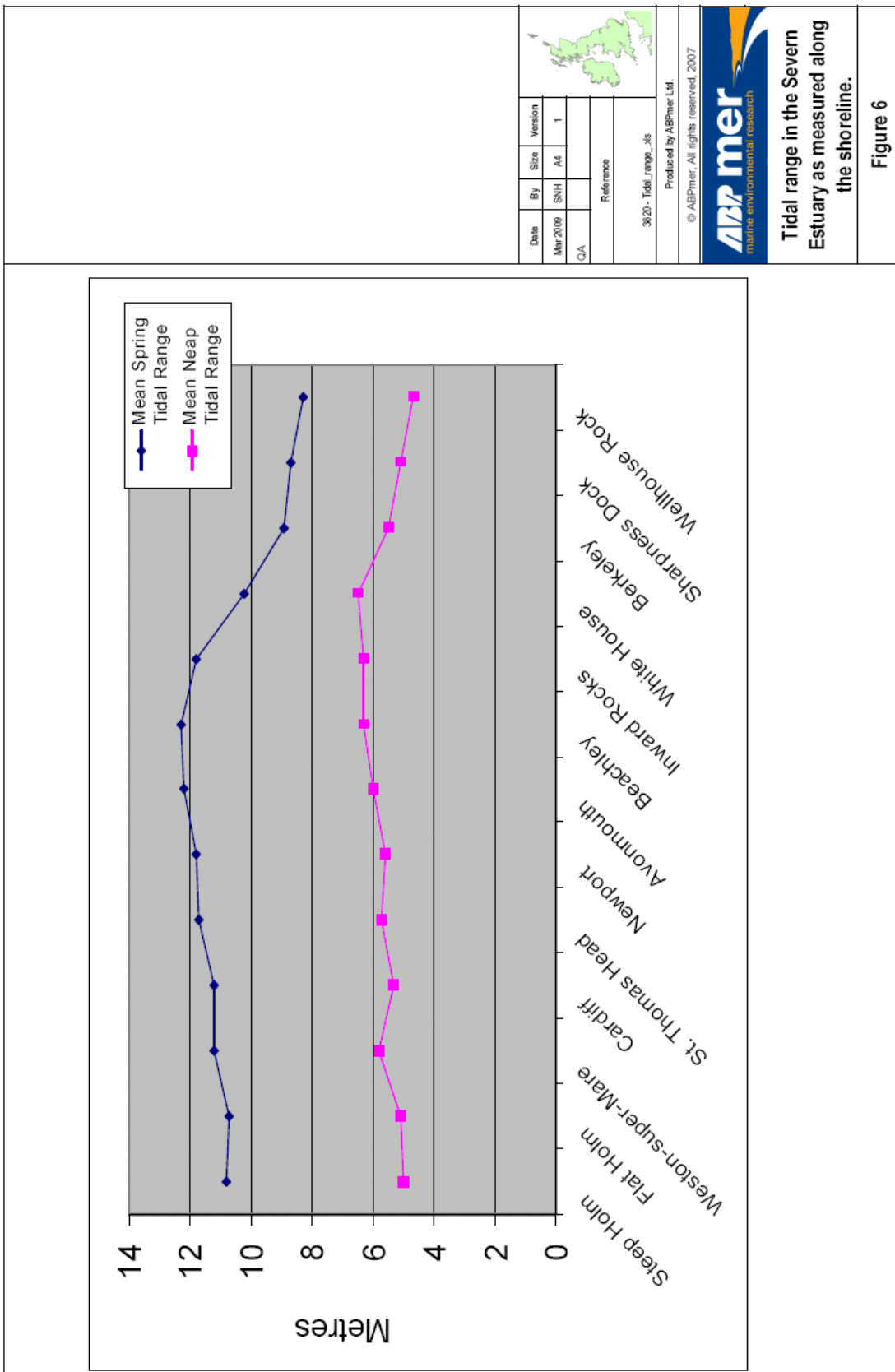

Date	By	Size	Version
Mar 2009	SNH	A4	1

CA	Reference
----	-----------

3020 - Tidal_range_v46
 Produced by ABPmer Ltd.
 © ABPmer. All rights reserved, 2007

Tidal range in the Severn Estuary as measured along the shoreline.

Figure 6

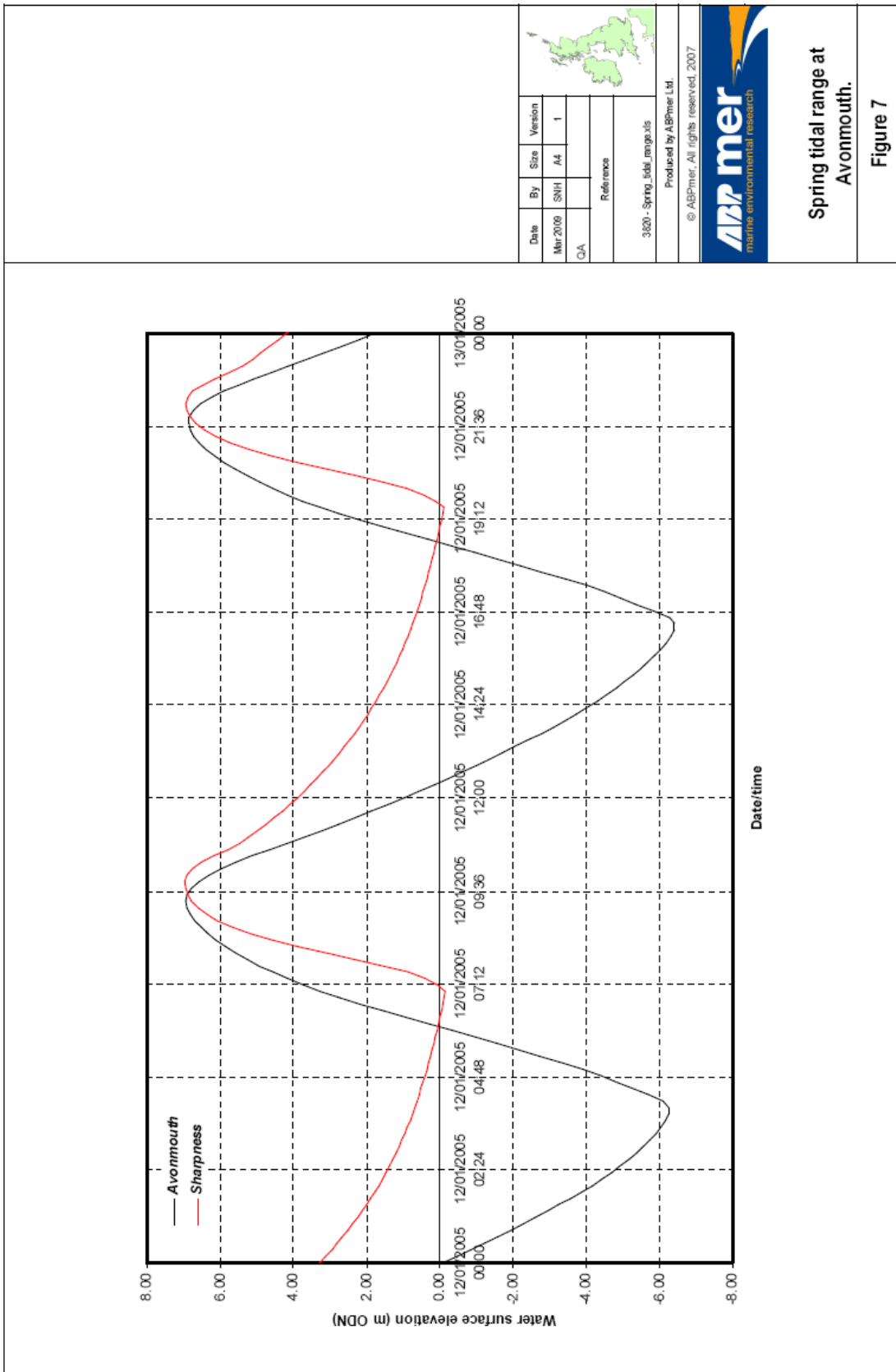

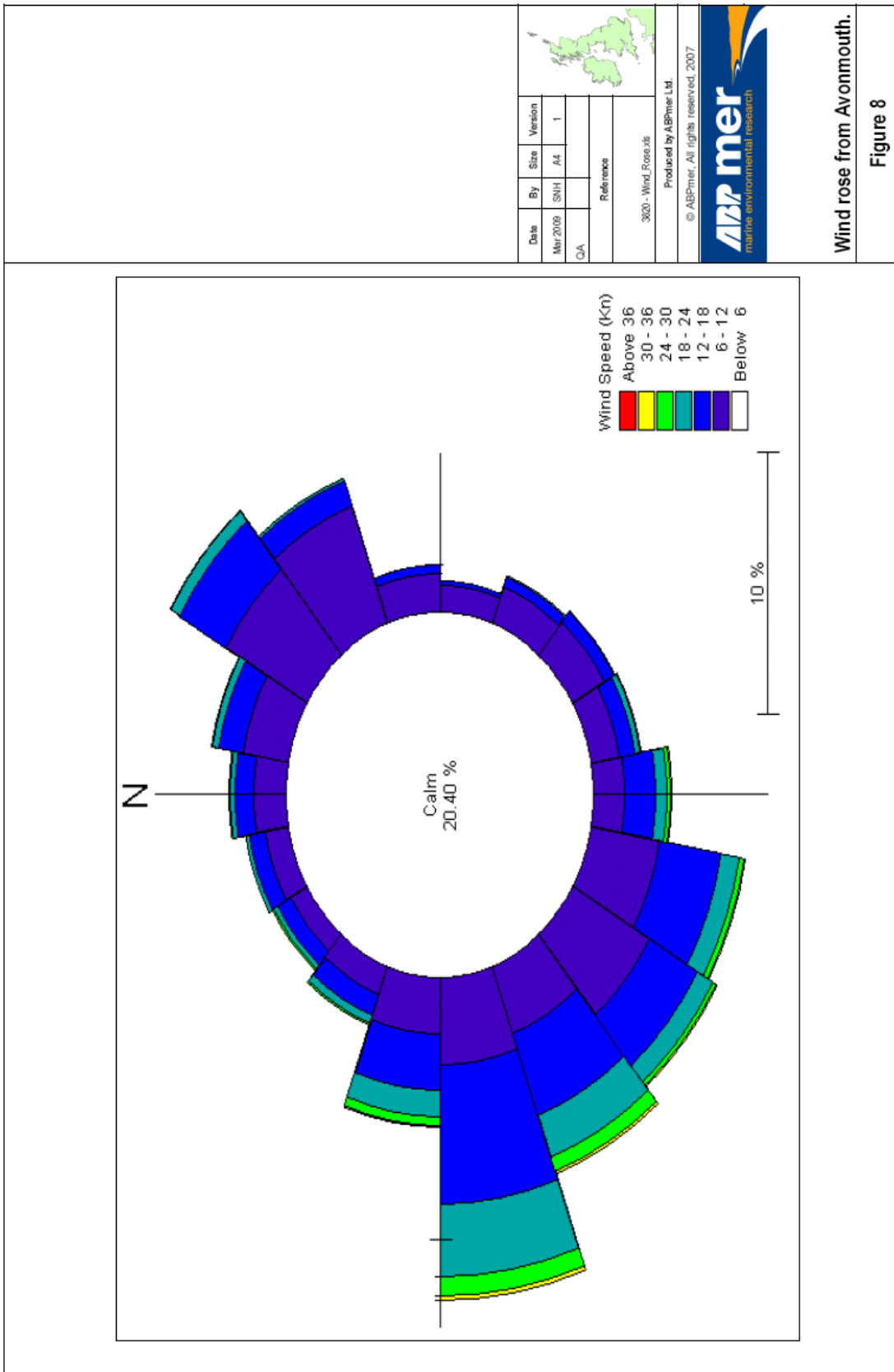

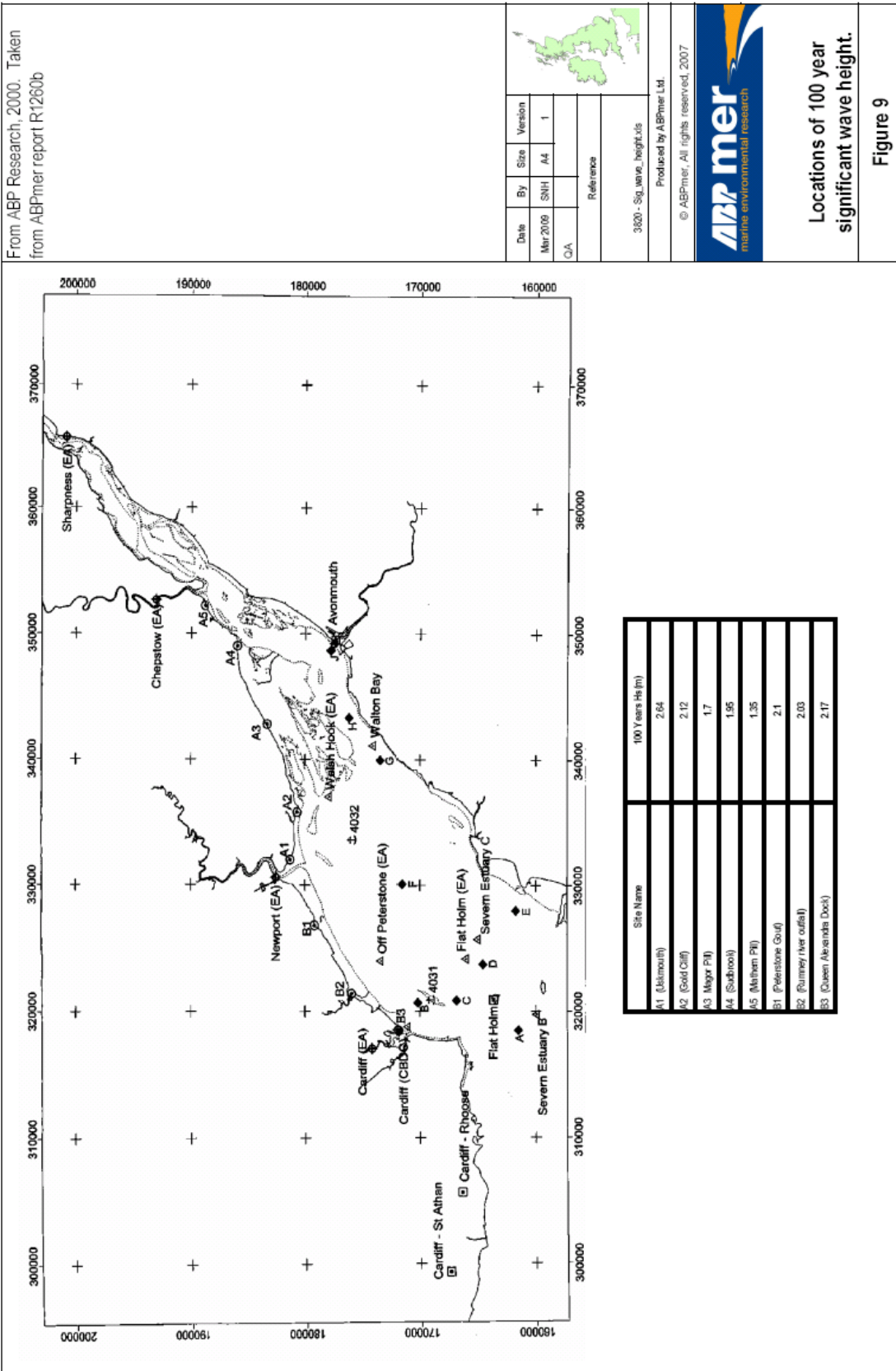

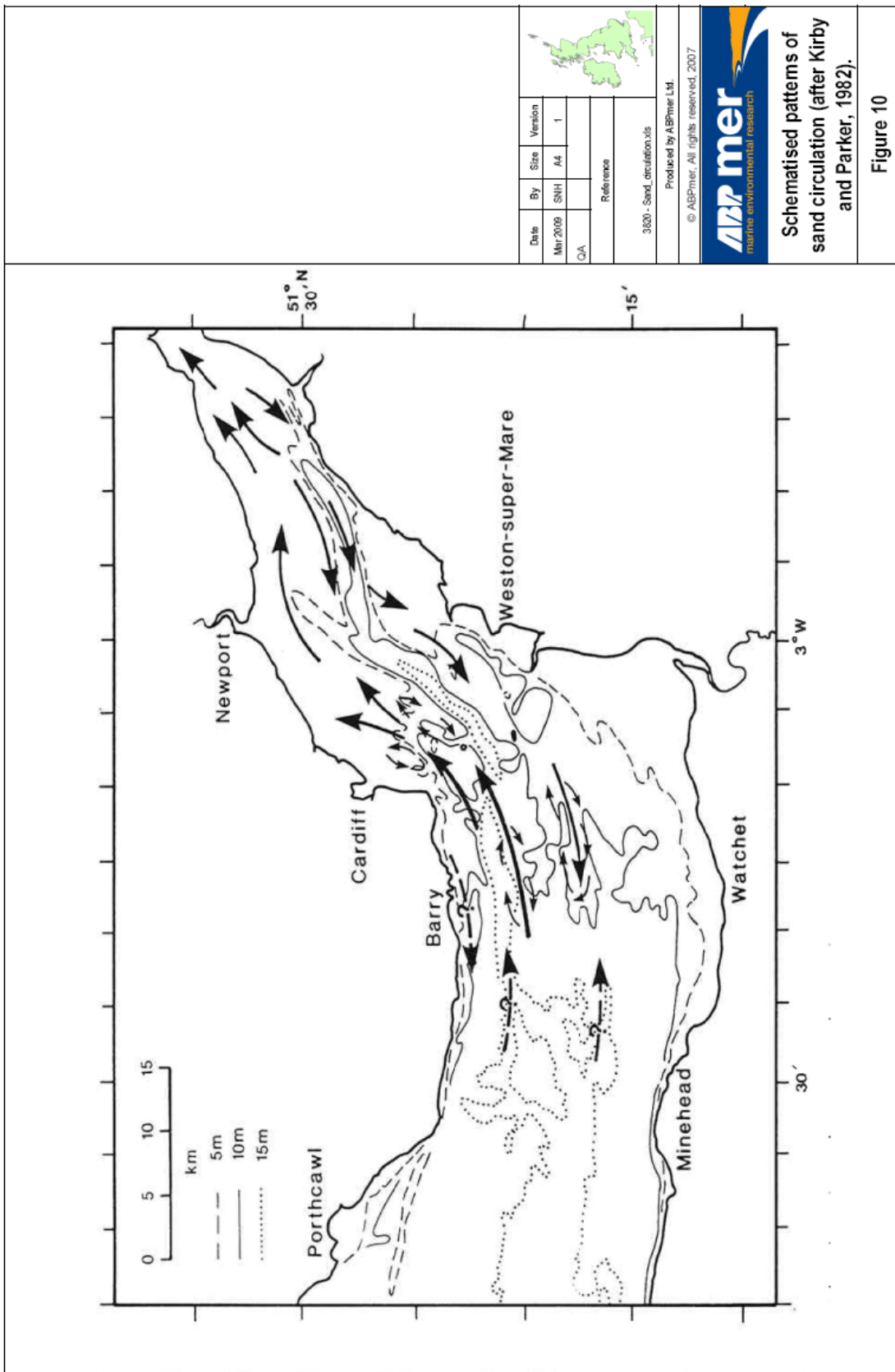

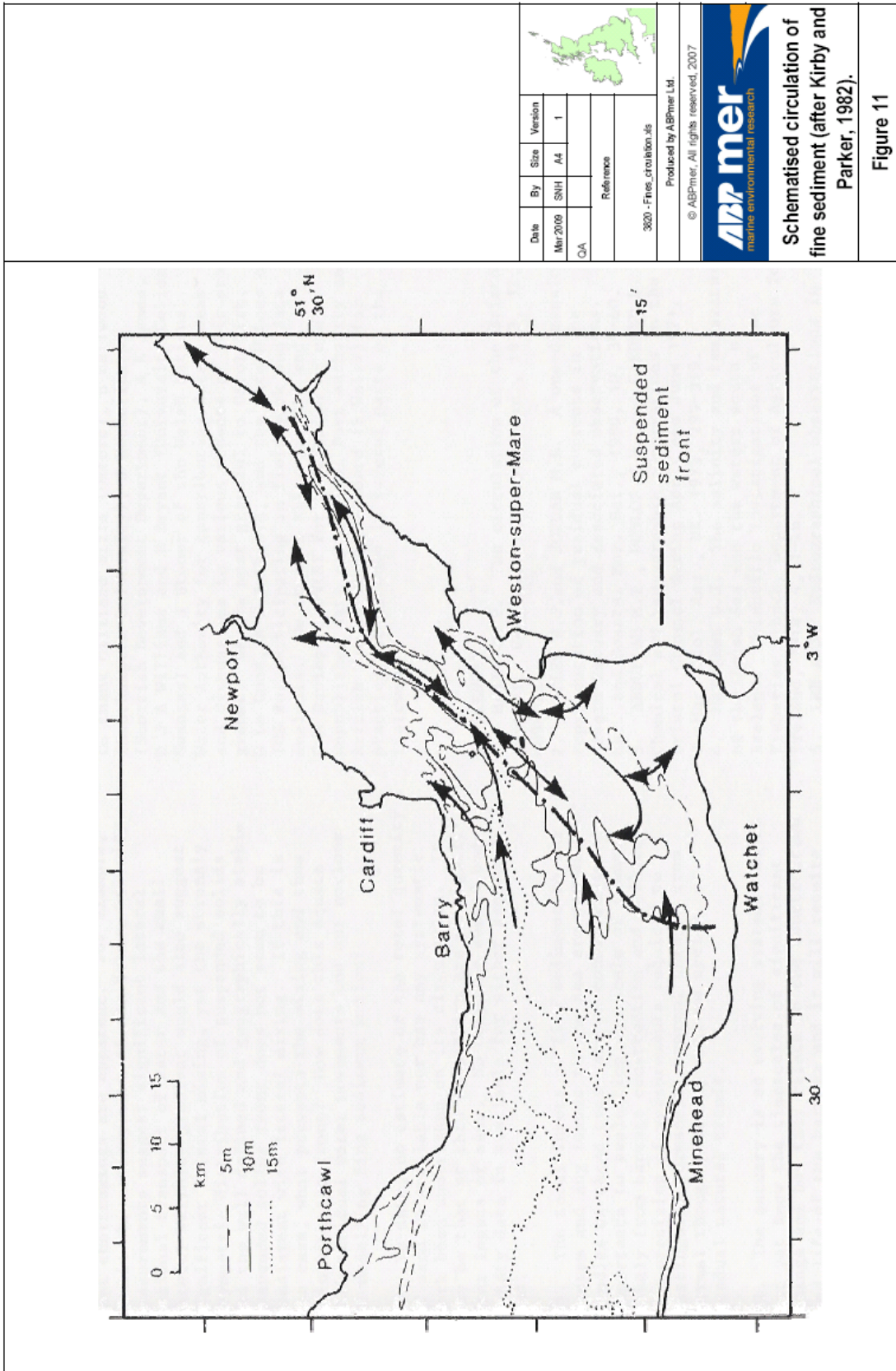

PART B - Coastal Defence Report

This Part details the condition of the defences along the SMP coast between Anchor Head and Lavernock Point. The data has been sourced from, the 1994 and 1997 MAFF coastal protection surveys, the previous SMP's and updated where possible using more recent data from NFCDD new surveys and the Severn FRM strategy. Local Authority engineers were contacted during the defence assessment process to confirm the distribution of defences and inform the SMP2 of additional defences. Residual life is considered in broad-terms, looking at decadal time over 20, 50 and 100 years as guided by Defra (2006). In addition to present condition of the structure, estimates of residual life were reconsidered against the current state of the foreshore, general levels of exposure and the results of the assessment of coastal processes and evolution.

Location	FCERM asset description	Natural features	FCERM asset condition	Standard of Protection	Residual life	Sources of information
Penarth						
Lavernock Point to Cliff Road	No defences from Lavernock Point to Forest Road (top of Cliff Hill). Concrete and masonry sea wall alongside Cliff Hill.	Triassic mudstone cliff. Muddy foreshore with boulders. Predominant wave processes.	Fair condition.	No flood risk.	20-50 years.	Based on local authority data.
Cliff Road to The Kymin	Near vertical concrete seawall with minor re-curve.	Sandy foreshore with gravel. Predominant wave processes.	Fair condition.	5% AEP wave overtopping risk (limited flooding occurs).	<20 years.	Based on local authority data.
Penarth Head	System of four groynes at the northern extent.	Triassic mudstone cliff with gravel foreshore. Predominant wave and tide processes.	Fair condition.	No flood risk.	<20 years.	Based on local authority data.
Cardiff						
Cardiff Bay Barrage	Cardiff Bay Barrage rock armoured concrete embankment.	Muddy foreshore. Predominant tidal processes.	Good condition.	Greater than 0.1% AEP for flood risk.	50-100 years.	Based on NFCDD, visual inspection and Severn FRM Strategy (Atkins, 2009).
Cardiff Flats to Pengam Moor	Made ground with intermittent rock armouring.	Muddy foreshore. Predominant tidal processes.	Poor to fair condition.	Greater than 0.1% AEP for flood risk.	<20 years.	Based on NFCDD, visual inspection and Severn FRM Strategy (Atkins, 2009).
River Rhymney	Earth embankments, flood walls, tipped rubble at Little	Meandering river with muddy sediments. Predominant tidal	Poor to fair condition.	0.5% AEP for flood risk.	<50 years.	Based on Gwent Levels FMP (Atkins, 2004) and Severn FRM Strategy

Location	FCERM asset description	Natural features	FCERM asset condition	Standard of Protection	Residual life	Sources of information
	Wharf and rock armoured outfall at eastern boundary.	processes.				(Atkins, 2009).
Wentlooge Levels						
Rumney Great Wharf	Earth embankment protected by rock armoured wharf, and fronting system of five polders. Derelict timber groyne.	Muddy foreshore with saltmarsh. Predominant wave and tidal processes.	Fair condition.	0.5%-0.1% AEP for flood risk.	20-50 years.	Based on NFCDD, visual inspection, Gwent Levels FMP (Atkins, 2004) and Severn FRM Strategy (Atkins, 2009).
Peterstone Great Wharf	Primary earth embankment with fronting wharf and saltings.	Muddy foreshore with saltmarsh. Predominant wave and tidal processes.	Fair condition.	Minimum of 5% AEP, more generally 0.5% AEP for flood risk.	<20 years.	Based on NFCDD, visual inspection, Gwent Levels FMP (Atkins, 2004) and Severn FRM Strategy (Atkins, 2009).
Peterstone Gout to east of Outfall Lane	Earth embankment with fronting revetment. Degraded timber groyne.	Muddy foreshore. Predominant wave and tidal processes.	Good condition.	Greater than 0.1% AEP for flood risk.	20-50 years.	Based on NFCDD, visual inspection, Gwent Levels FMP (Atkins, 2004) and Severn FRM Strategy (Atkins, 2009).
East of Outfall Lane to River Ebbw (west bank)	Earth embankment with fronting revetment and wharf cliff protected by rock armouring. Degraded stone groynes.	Muddy foreshore with saltmarsh. Predominant wave and tidal processes.	Fair condition.	Greater than 0.1% AEP for flood risk.	20-50 years.	Based on NFCDD, visual inspection, Gwent Levels FMP (Atkins, 2004) and Severn FRM Strategy (Atkins, 2009).

Location	FCERM asset description	Natural features	FCERM asset condition	Standard of Protection	Residual life	Sources of information
Newport Area and the River Usk						
Ebbw River to the Transporter Bridge (right bank)	Earth embankments.	Meandering river with muddy sediments. Predominant tidal processes.	Fair condition.	5 to 100% AEP for flood risk.	<20 years.	Based on Tidal Usk FRM Strategy (Halcrow, 2008).
Transporter Bridge to the M4 motorway (right bank)	Earth embankments and masonry walls.	Meandering river with muddy sediments. Predominant tidal processes.	Fair to good condition.	20% AEP for flood risk.	<20 years.	Based on Tidal Usk FRM Strategy (Halcrow, 2008).
M4 motorway to Newbridge on Usk (both banks)	Earth embankments and masonry walls.	Meandering river with muddy sediments. Predominant tidal processes.	Fair to good condition.	5% to 100% AEP for flood risk.	<20 years for earth embankments. 20-50 years for masonry walls.	Based on Tidal Usk FRM Strategy (Halcrow, 2008).
M4 motorway to Spytty Pill (left bank)	Earth embankments and reinforced concrete walls.	Meandering river with muddy sediments. Predominant tidal processes.	Fair condition.	0.5% to 20% AEP for flood risk.	<20 years for earth embankments. 20-50 years for reinforced concrete walls.	Based on Tidal Usk FRM Strategy (Halcrow, 2008).
Spytty Pill to Uskmouth Power Station (left bank)	Earth embankment and high ground.	Meandering river with muddy sediments. Predominant tidal processes.	Poor to fair condition.	0.5% to 100% AEP for flood risk.	<20 years.	Based on Tidal Usk FRM Strategy (Halcrow, 2008).
Uskmouth Power Station (AES Fifoots PS) to Saltmarsh Farm	Revetment with wave wall. Degraded Nash breakwater.	Muddy foreshore with saltmarsh. Predominant wave and tidal	Good condition.	Greater than 0.1% AEP for flood risk.	20-50 years.	Based on NFCDD, visual inspection, Gwent Levels FMP (Atkins, 2004) and Severn Estuary FRM

Location	FCERM asset description	Natural features	FCERM asset condition	Standard of Protection	Residual life	Sources of information
		processes.				Strategy (Atkins, 2009).
Saltmarsh Farm to Gold Cliff	Concrete revetment with rock armouring. System of four stone groyne at Goldcliff Head.	Muddy foreshore with saltmarsh. Predominant wave and tidal processes.	Good condition.	Greater than 0.1% AEP for flood risk.	20-50 years.	Based on NFCDD, visual inspection, Gwent Levels FMP (Atkins, 2004) and Severn Estuary FRM Strategy (Atkins, 2009).
Caldicot Levels						
Gold Cliff to West Pill	Earth embankment with rock armouring or concrete revetment. Degraded stub breakwaters.	Muddy foreshore. Predominant wave and tidal processes.	Fair to good condition.	Greater than 0.1% AEP for flood risk.	20-50 years.	Based on NFCDD, visual inspection, Gwent Levels FMP (Atkins, 2004) and Severn Estuary FRM Strategy (Atkins, 2009).
West Pill to West of Sudbrook Point	Earth embankment with rock armouring.	Muddy foreshore with saltmarsh. Predominant wave and tidal processes.	Fair condition.	0.5% AEP for flood risk.	20-50 years.	Based on NFCDD, visual inspection, Gwent Levels FMP (Atkins, 2004) and Severn Estuary FRM Strategy (Atkins, 2009).
Sudbrook Point to Black Rock	Rock armour and groyne system.	Old Red Sandstone headland. Predominant wave and tidal processes.	Poor to fair condition	High ground precludes flooding.	<20 years.	Based on Gwent Levels FMP (Atkins, 2004) and local authority data.
Black Rock to	Rock armoured and earth	Muddy foreshore with saltmarsh.	Fair condition.	0.5% AEP for flood	20-50 years.	Based on NFCDD, visual inspection,

Location	FCERM asset description	Natural features	FCERM asset condition	Standard of Protection	Residual life	Sources of information
Thornwell	embankments.	Predominant wave and tidal processes.		risk.		Gwent Levels FMP (Atkins, 2004) and Severn Estuary FRM Strategy (Atkins, 2009).
Beachley Point	High ground.	Hard geology cliff. Predominant wave and tidal processes.	Not applicable.	Not applicable.	Not applicable.	Based on NFCDD and visual inspection.
Chepstow, the River Wye and surrounding Area						
Thornwell to Alcove Wood (right bank)	High ground and flood walls.	Hard geology river with muddy sediments. Predominant tidal processes.	Good condition.	0.5% AEP for flood risk.	20-50 years.	Based on Wye and Usk CFMP (EA, 2008).
Alcove Wood-Chapel House Wood to Tintern Abbey (both banks)	High ground.	Hard geology river with muddy sediments. Predominant tidal processes.	Not applicable.	Not applicable.	Not applicable.	Based on Wye and Usk CFMP (EA, 2008).
Chapel House Wood to Sedbury Sewage Works (left bank)	High ground.	Hard geology river with muddy sediments. Predominant tidal processes.	Not applicable.	Not applicable.	Not applicable.	Based on Wye and Usk CFMP (EA, 2008).
Sedbury Sewage Works to north Beachley (left bank)	High and low ground.	Hard geology river with muddy sediments. Predominant tidal processes.	Not applicable.	Not applicable.	Not applicable.	Based on Wye and Usk CFMP (EA, 2008).

Location	FCERM asset description	Natural features	FCERM asset condition	Standard of Protection	Residual life	Sources of information
Chepstow to Lydney						
Beachley to Pillhouse Rocks	Predominantly high ground, with embankment at Sturch Pill.	Hard geology cliff with rock outcrops, muddy foreshore with intermittent saltmarsh and sandbanks. Predominant wave and tidal processes.	Fair condition.	0.5% AEP for flood risk.	<20 years.	Based on Tidal Severn FRM Strategy (EA, 2006) and Severn Estuary FRM Strategy (Atkins, 2009).
Pillhouse Rocks to Guscar Rocks	Railway embankment with failed tide flaps, and intermittent high ground.	Rock outcrops and muddy foreshore, with intermittent saltmarsh and sandbanks. Predominant wave and tidal processes.	Not applicable.	Constrained flooding occurs during extreme events.	Not applicable.	Based on Tidal Severn FRM Strategy (EA, 2006) and Severn Estuary FRM Strategy (Atkins, 2009).
Lydney						
Guscar Rocks to/and Lydney Harbour	Rock armoured embankment.	Rock outcrops and muddy foreshore, with sandbanks. Predominant wave and tidal processes.	Good condition.	Greater than 0.1% AEP for flood risk.	20-50 years.	Based on Tidal Severn FRM Strategy (EA, 2006) and Severn Estuary FRM Strategy (Atkins, 2009).
Lydney to Gloucester						
Lydney Harbour to Wellhouse Rock (right bank)	High ground, railway retaining wall and embankment.	Hard geology cliff with rock outcrops, muddy foreshore and sandbanks. Predominant tidal	Good condition.	0.5% AEP for flood risk.	20-50 years.	Based on Tidal Severn FRM Strategy (EA, 2006) and Severn Estuary FRM Strategy (Atkins,

Location	FCERM asset description	Natural features	FCERM asset condition	Standard of Protection	Residual life	Sources of information
		processes.				2009).
Wellhouse Rock to Poulton Court (right bank)	High ground and railway retaining wall.	Meandering river with muddy and sandy sediments. Predominant tidal processes.	Fair condition.	Not applicable.	20-50 years.	Based on Tidal Severn FRM Strategy (EA, 2006) and Severn Estuary FRM Strategy (Atkins, 2009).
Poulton Court to Whitescourt (right bank)	High ground and earth embankment.	Meandering river with muddy and sandy sediments. Predominant tidal processes.	Poor to fair condition.	5% AEP for flood risk.	<20 years.	Based on Tidal Severn FRM Strategy (EA, 2006) and Severn Estuary FRM Strategy (Atkins, 2009).
Whitescourt to Northingham Farm (right bank)	Embankments with some masonry protection.	Meandering river with muddy and sandy sediments. Predominant tidal processes.	Poor to fair condition.	20% AEP for flood risk.	<20 years.	Based on Tidal Severn FRM Strategy (EA, 2006) and Severn Estuary FRM Strategy (Atkins, 2009).
Northington Farm to Newnham (right bank)	High ground and earth embankments.	Meandering river with muddy and sandy sediments. Predominant tidal and fluvial processes.	Not applicable.	Constrained flooding occurs during extreme events.	Not applicable.	Based on Tidal Severn FRM Strategy (EA, 2006) and Severn Estuary FRM Strategy (Atkins, 2009).
Newnham to Broadoak (right bank)	High ground, earth embankment and flood walls.	Meandering river with muddy and sandy sediments. Predominant tidal and fluvial processes.	Fair condition.	5% AEP for flood risk.	<20 years.	Based on Tidal Severn FRM Strategy (EA, 2006) and Severn Estuary FRM Strategy (Atkins, 2009).

Location	FCERM asset description	Natural features	FCERM asset condition	Standard of Protection	Residual life	Sources of information
Broadoak to Garden Cliff (right bank)	High ground and earth embankment.	Meandering river with muddy and sandy sediments. Predominant tidal and fluvial processes.	Fair condition.	5% AEP for flood risk.	<20 years.	Based on Tidal Severn FRM Strategy (EA, 2006) and Severn Estuary FRM Strategy (Atkins, 2009).
Garden Cliff to Rodley (right bank)	High ground and earth embankment.	Meandering river with muddy and sandy sediments. Predominant tidal and fluvial processes.	Fair condition.	5% AEP for flood risk.	<20 years.	Based on Tidal Severn FRM Strategy (EA, 2006) and Severn Estuary FRM Strategy (Atkins, 2009).
Rodley to Bollow (right bank)	High ground.	Meandering river with muddy and sandy sediments. Predominant tidal and fluvial processes.	Not applicable.	Not applicable.	Not applicable.	Based on Tidal Severn FRM Strategy (EA, 2006) and Severn Estuary FRM Strategy (Atkins, 2009).
Bollow to Walmore Common (right bank)	High ground and earth embankment.	Meandering river with muddy and sandy sediments. Predominant tidal and fluvial processes.	Fair condition.	1% AEP for flood risk.	20-50 years.	Based on Tidal Severn FRM Strategy (EA, 2006) and Severn Estuary FRM Strategy (Atkins, 2009).
Walmore Common to Oakle Street (right bank)	High ground, earth embankment and flood walls.	Meandering river with muddy sediments. Predominant tidal and fluvial processes.	Fair condition.	5% AEP for flood risk.	<20 years.	Based on Tidal Severn FRM Strategy (EA, 2006) and Severn Estuary FRM Strategy (Atkins, 2009).
Oakle Street to	High ground and	Meandering river	Fair condition.	10% AEP for flood	<20 years.	Based on Tidal

Location	FCERM asset description	Natural features	FCERM asset condition	Standard of Protection	Residual life	Sources of information
Highcross Farm (right bank)	Earth embankment.	with muddy sediments. Predominant fluvial processes.		risk.		Severn FRM Strategy (EA, 2006) and Severn Estuary FRM Strategy (Atkins, 2009).
Gloucester to Haw Bridge						
Highcross Farm to Over Bridge (right bank)	Earth embankment (set back).	Meandering river with muddy sediments. Predominant fluvial processes.	Fair condition.	10% AEP for flood risk.	<20 years.	Based on Tidal Severn FRM Strategy (EA, 2006) and Severn Estuary FRM Strategy (Atkins, 2009).
Over Bridge to Maisemore Weir (right bank)	High ground and earth embankment.	Meandering river with muddy sediments. Predominant fluvial processes.	Fair condition.	10% AEP for flood risk.	<20 years.	Based on Tidal Severn FRM Strategy (EA, 2006) and Severn Estuary FRM Strategy (Atkins, 2009).
Maisemore Weir to Ashleworth (right bank)	Earth embankment and low ground.	Meandering river with muddy sediments. Predominant fluvial processes.	Fair to good condition.	100% AEP for flood risk.	<20 years.	Based on NFCDD.
Ashleworth to Haw Bridge (right bank)	Earth embankment.	Meandering river with muddy sediments. Predominant fluvial processes.	Good condition.	>5% AEP for flood risk	<20 years.	Based on NFCDD.
Alney Island	High ground and flood walls.	Meandering river with muddy sediments.	Good condition.	10% to 100% AEP for flood risk.	<20 years.	Based on NFCDD.

Location	FCERM asset description	Natural features	FCERM asset condition	Standard of Protection	Residual life	Sources of information
		Predominant fluvial processes.				
Haw Bridge to Ashleworth (left bank)	Earth embankment and low ground.	Meandering river with muddy sediments. Predominant fluvial processes.	Good condition.	>5% AEP for flood risk.	<20 years.	Based on NFCDD.
Ashleworth to Llanthony Weir (left bank)	Earth embankment and low ground.	Meandering river with muddy sediments. Predominant fluvial processes.	Fair condition.	>5% AEP for flood risk.	<20 years.	Based on NFCDD.
Llanthony Weir to Rea (left bank)	High ground, earth embankment and flood walls.	Meandering river with muddy sediments. Predominant fluvial processes.	Poor to fair condition.	10% AEP for flood risk.	<20 years.	Based on Tidal Severn FRM Strategy (EA, 2006) and Severn Estuary FRM Strategy (Atkins, 2009).
The Rea to Stonebench (left bank)	High ground.	Meandering river with muddy sediments. Predominant fluvial processes.	Not applicable.	Not applicable.	Not applicable.	Based on Tidal Severn FRM Strategy (EA, 2006) and Severn Estuary FRM Strategy (Atkins, 2009).
Gloucester to Sharpness						
Stonebench to Windmill Hill (left bank)	High ground and earth embankment.	Meandering river with muddy sediments. Predominant fluvial processes.	Fair condition.	100% AEP for flood risk.	<20 years.	Based on Tidal Severn FRM Strategy (EA, 2006) and Severn Estuary FRM Strategy (Atkins,

Location	FCERM asset description	Natural features	FCERM asset condition	Standard of Protection	Residual life	Sources of information
						2009).
Windmill Hill to Waterend (left bank)	Earth embankment.	Meandering river with muddy sediments. Predominant tidal and fluvial processes.	Good condition.	2% AEP for flood risk.	20-50 years.	Based on Tidal Severn FRM Strategy (EA, 2006) and Severn Estuary FRM Strategy (Atkins, 2009).
Waterend to Longney Crib (left bank)	Earth embankment (floodplain obstruction).	Meandering river with muddy and sandy sediments. Predominant tidal and fluvial processes.	Good condition.	0.5% AEP for flood risk.	20-50 years.	Based on Tidal Severn FRM Strategy (EA, 2006) and Severn Estuary FRM Strategy (Atkins, 2009).
Longney Crib to Cobbie's Rock (left bank)	Earth embankment and flood wall.	Meandering river with muddy and sandy sediments. Predominant tidal and fluvial processes.	Fair condition.	0.5% AEP for flood risk.	20-50 years.	Based on Tidal Severn FRM Strategy (EA, 2006) and Severn Estuary FRM Strategy (Atkins, 2009).
Cobbie's Rock to Priding (left bank)	High ground, earth embankment and flood walls.	Meandering river with muddy and sandy sediments. Predominant tidal and fluvial processes.	Fair condition.	2% AEP for flood risk.	20-50 years.	Based on Tidal Severn FRM Strategy (EA, 2006) and Severn Estuary FRM Strategy (Atkins, 2009).
Priding to Hock Cliff (left bank)	High ground and earth embankment.	Meandering river with muddy and sandy sediments. Predominant tidal and fluvial processes.	Fair condition.	0.5% AEP for flood risk.	20-50 years.	Based on Tidal Severn FRM Strategy (EA, 2006) and Severn Estuary FRM Strategy (Atkins, 2009).

Location	FCERM asset description	Natural features	FCERM asset condition	Standard of Protection	Residual life	Sources of information
Hock Cliff to Hock Ditch (left bank)	High ground.	Meandering river with muddy and sandy sediments. Predominant tidal processes.	Not applicable.	Not applicable.	Not applicable.	Based on Tidal Severn FRM Strategy (EA, 2006) and Severn Estuary FRM Strategy (Atkins, 2009).
Hock Ditch to Splatt Bridge (left bank)	Canal banks.	Meandering river with muddy and sandy sediments. Predominant tidal processes.	Fair condition.	0.1% AEP for flood risk.	20-50 years.	Based on Tidal Severn FRM Strategy (EA, 2006) and Severn Estuary FRM Strategy (Atkins, 2009).
Splatt Bridge to Royal Drift Outfall (left bank)	Earth embankment. System of five stone groynes.	Meandering river with muddy and sandy sediments. Predominant tidal processes.	Fair condition.	0.1% AEP for flood risk.	20-50 years.	Based on Tidal Severn FRM Strategy (EA, 2006) and Severn Estuary FRM Strategy (Atkins, 2009).
Royal Drift Outfall to Tites Point (left bank)	High ground.	Meandering river with muddy and sandy sediments. Predominant tidal processes.	Not applicable.	Not applicable.	Not applicable.	Based on Tidal Severn FRM Strategy (EA, 2006) and Severn Estuary FRM Strategy (Atkins, 2009).
Sharpness to Severn Crossings						
Tites Point to Saniger Pill (left bank)	Canal bank, fronted by sunken barges, and earth embankment.	Hard geology cliff with rock outcrops, muddy foreshore and sandbanks. Predominant tidal processes.	Fair condition.	1% AEP for flood risk.	20-50 years.	Based on Tidal Severn FRM Strategy (EA, 2006) and Severn Estuary FRM Strategy (Atkins, 2009).

Location	FCERM asset description	Natural features	FCERM asset condition	Standard of Protection	Residual life	Sources of information
Saniger Pill to Berkeley Pill	Earth embankment.	Muddy foreshore with sandbanks. Predominant wave and tidal processes.	Fair condition.	1% AEP for flood risk.	20-50 years.	Based on Tidal Severn FRM Strategy (EA, 2006) and Severn Estuary FRM Strategy (Atkins, 2009).
Berkely Pill to Hill Pill	Earth embankment.	Muddy foreshore with sandbanks. Predominant wave and tidal processes.	Fair condition.	2% AEP for flood risk.	20-50 years.	Based on Tidal Severn FRM Strategy (EA, 2006) and Severn Estuary FRM Strategy (Atkins, 2009).
Hill Pill to Oldbury Pill	Earth embankment.	Muddy foreshore with sandbanks. Predominant wave and tidal processes.	Poor to fair condition.	5% AEP for flood risk.	<20 years.	Based on Tidal Severn FRM Strategy (EA, 2006) and Severn Estuary FRM Strategy (Atkins, 2009).
Oldbury Pill to Littleton Pill	Earth embankment.	Muddy foreshore with sandbanks. Predominant wave and tidal processes.	Fair condition.	2% AEP for flood risk.	20-50 years.	Based on Tidal Severn FRM Strategy (EA, 2006) and Severn Estuary FRM Strategy (Atkins, 2009).
Littleton Pill to Aust Cliff	High ground and earth embankment.	Muddy foreshore. Predominant wave and tidal processes.	Fair condition.	0.5% AEP for flood risk.	20-50 years.	Based on Tidal Severn FRM Strategy (EA, 2006) and Severn Estuary FRM Strategy (Atkins, 2009).
Severnside, Bristol and Avon						

Location	FCERM asset description	Natural features	FCERM asset condition	Standard of Protection	Residual life	Sources of information
Aust Cliff to Old Passage	High ground.	Muddy foreshore. Predominant wave and tidal processes.	Not applicable.	Not applicable.	Not applicable.	Based on Tidal Severn FRM Strategy (EA, 2006) and Severn Estuary FRM Strategy (Atkins, 2009).
Old Passage to New Passage	Earth embankment.	Muddy foreshore with saltmarsh. Predominant wave and tidal processes.	Fair condition.	0.5% AEP for flood risk.	20-50 years.	Based on Tidal Severn FRM Strategy (EA, 2006) and Severn Estuary FRM Strategy (Atkins, 2009).
New Passage to Mitchell's Salt Rhine	Concrete revetment and railway embankment.	Muddy foreshore with saltmarsh. Predominant wave and tidal processes.	Fair condition.	0.1% AEP for flood risk.	20-50 years.	Based on Tidal Severn FRM Strategy (EA, 2006) and Severn Estuary FRM Strategy (Atkins, 2009).
Mitchell's Salt Rhine to Avonmouth Pier	Earth embankment with tipped rubble at the toe, concrete wall.	Muddy foreshore with saltmarsh. Predominant wave and tidal processes.	Poor condition.	5% AEP for flood risk.	<20 years.	Based on Tidal Severn FRM Strategy (EA, 2006) and Severn Estuary FRM Strategy (Atkins, 2009).
Avonmouth Pier to M5 motorway (right bank)	Avonmouth Dock jetties and earth embankments with tipped rubble.	River with muddy sediments. Predominant tidal processes.	Poor condition.	5% AEP for flood risk.	<20 years.	Based on Tidal Severn FRM Strategy (EA, 2006) and Severn Estuary FRM Strategy (Atkins, 2009).
M5 motorway to	High ground, earth	River with muddy	Poor to good	1% AEP for flood	<50 years.	Based on NFCDD,

Location	FCERM asset description	Natural features	FCERM asset condition	Standard of Protection	Residual life	Sources of information
Cumberland Basin (right bank)	embankments and concrete/masonry walls.	sediments. Predominant tidal processes.	condition.	risk.		Local Authority data and photographs.
Cumberland Basin to Netham Weir (both banks)	Lock gates, earth embankments and concrete/masonry walls.	River with muddy sediments. Predominant tidal processes.	Poor to good condition.	2% to 0.2% AEP for flood risk.	<50 years.	Based on NFCDD, local authority data and photographs.
Cumberland Basin to Pill (left bank)	High ground, earth embankments and masonry walls.	River with muddy sediments. Predominant tidal processes.	Poor to fair condition.	1% to 100% AEP for flood risk.	<50 years	Based on NFCDD, local authority data and photographs.
Pill to Portbury Pier (left bank)	Earth embankment and high ground.	River with muddy sediments. Predominant tidal processes.	Poor condition.	0.1% AEP for flood risk.	<20 years.	Based on Severn Estuary FRM Strategy (Atkins, 2009).
Portbury Pier to west of the Old Pier, Portishead	Royal Portbury Dock pier and earth embankment.	Muddy foreshore with saltmarsh. Predominant wave and tidal processes.	Fair condition.	0.5% AEP for flood risk.	20-50 years.	Based on Severn Estuary FRM Strategy (Atkins, 2009).
Portishead and Clevedon						
Old Pier, Portishead to Portishead Point	Old Pier and high ground.	Resistant carboniferous limestone cliff coast. Predominant wave and tidal processes.	Not applicable.	Not applicable.	Not applicable.	Based on Severn Estuary FRM Strategy (Atkins, 2009).
Woodhill Bay	Masonry wall and promenade.	Muddy foreshore with saltmarsh. Predominant wave	Good condition.	0.1% AEP for flood risk.	20-50 years.	Based on Severn Estuary FRM Strategy (Atkins,

Location	FCERM asset description	Natural features	FCERM asset condition	Standard of Protection	Residual life	Sources of information
		and tidal processes.				2009).
Kilkenny Bay to Ladye Point	High ground.	Resistant carboniferous limestone cliff coast. Predominant wave and tidal processes.	Not applicable.	Not applicable.	Not applicable.	Based on Severn Estuary FRM Strategy (Atkins, 2009).
Clevedon	Masonry walls.	Muddy foreshore with cobbles and rock platform. Predominant wave and tidal processes.	Good condition.	0.5% AEP for flood risk.	20-50 years.	Based on Severn Estuary FRM Strategy (Atkins, 2009).
Kingston Seymour to Sand Bay						
Wains Hill to St. Thomas Head (Kingston Seymour Bay)	Rock armoured, asphalted and earth embankments.	Muddy foreshore with saltmarsh. Predominant wave and tidal processes.	Good condition.	Generally 0.5% AEP for flood risk, 5% AEP for fluvial embankments.	Generally 20-50 years, <20 years for fluvial embankments.	Based on Severn Estuary FRM Strategy (Atkins, 2009).
St. Thomas Head to Sand Point	High ground.	Resistant carboniferous limestone cliff coast. Predominant wave and tidal processes.	Not applicable.	Not applicable.	Not applicable.	Based on Severn Estuary FRM Strategy (Atkins, 2009).
Sand Bay	Sand dunes.	Sand dunes. Predominant wave and tidal processes.	Good condition.	0.5% AEP for flood risk.	20-50 years.	Based on Severn Estuary FRM Strategy (Atkins, 2009).

Location	FCERM asset description	Natural features	FCERM asset condition	Standard of Protection	Residual life	Sources of information
South Kewstroke to Birnbeck Island	High ground.	Hard geology. Predominant wave and tidal processes.	Not applicable.	Not applicable.	Not applicable.	Based on Severn Estuary FRM Strategy (Atkins, 2009).
The Holms						
Flat Holm	High ground.	Hard geology. Predominant wave/ tidal processes.	Not applicable.	Not applicable.	Not applicable.	Based on photographs.
Steep Holm	High ground.	Hard geology. Predominant wave/ tidal processes.	Not applicable.	Not applicable.	Not applicable.	Based on photographs.

Annex: NFCDD Survey Update Coastline (Atkins 2009)

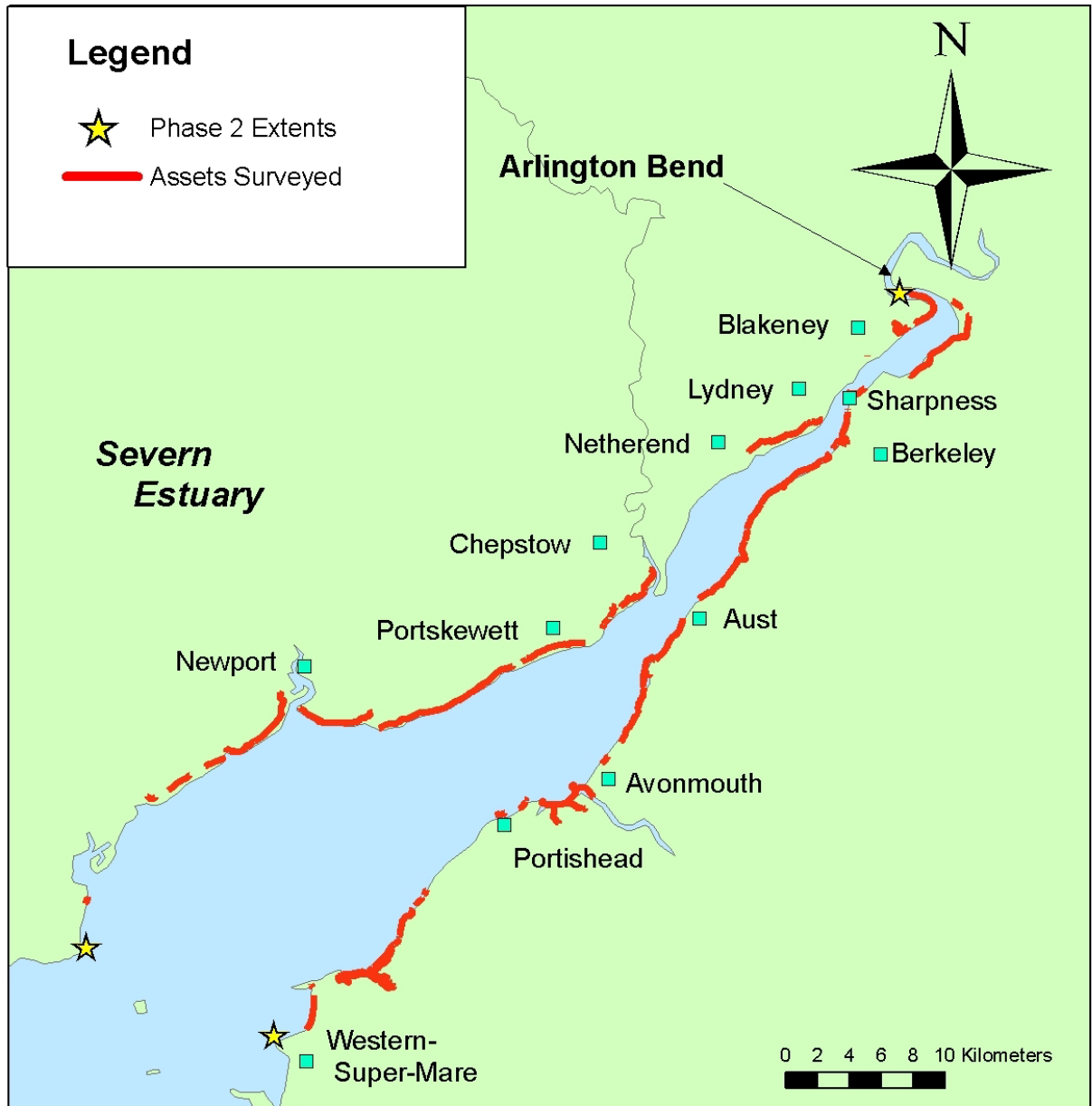

Annex B: Local Authorities Defence Enquires

Your Ref:

Our Ref: 5078599/60/62/2.3 - L02

Ext No: 8323

19 February 2009

Severn Estuary Shoreline Management Plan – Defence Length Clarification

Dear Sirs

The first Shoreline Management Plan (SMP) for the Severn was produced in 2000. This plan is now under review (known hereon in as SMP2). The Severn Estuary SMP2 covers the area of coast from Lavernock Point near Penarth, Wales, up to Haw Bridge near Gloucester and down to Anchor Head, east of Weston Bay, in England. The SMP2 will include rivers that flow into the Estuary up to their tidal limit and stretch inland to the locations within the 1 in 1000 year flood zone.

A SMP provides a large-scale assessment of the risks associated with coastal processes and the way that the coastline transforms over time. This assessment then provides the evidence to help inform the development of present and long term policies. These policies are used to reduce the risks to people, developments and historic and natural environments, in a sustainable manner.

An important stage of the SMP2 in allowing policies to develop is the identification of all coastal defences within the study boundary. We have identified a number of these defences that fall within your authority already, and would like further information on other defences (e.g.: private owners etc) that may have been missed from our study to date.

In the first instance we would like to review the coastal defence data (enclosed) and fill in / amend the tables enclosed.

We are working to a strict deadline and would appreciate a rapid response to this request before Friday 27th February. If you require any further data from us please do not hesitate to call.

For more information on the SMP2 visit www.severnestuary.net/secg

Yours faithfully,

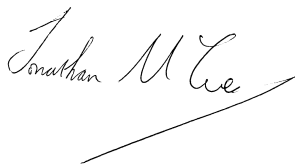

For and on behalf of Atkins Limited

Jonathan McCue
Project Manager, Rivers & Coastal Warrington

Jonathan.McCue@atkinsglobal.com

Enquiry to the Local Authority: **Stroud**

A unique code provided to each coastal defences asset - New references will be assigned by the Operating Authority (Environment Agency \ Local Authority)	Please provide engineering drawing reference	This data will be obtained from Operating Authorities : Environment Agency, Local Authority or Private	The design standard of the defence defined as a return period in years, if known	Any comment?
Asset Reference	Engineering Drawing Reference	Maintainer	Design Standard	Comments
112GF22210202C01		Private	200	
112GF22210202C02		Private	200	
112GF22210202C03		Private	200	
112GF22210202C04		Private	200	
112GF22210203C06		Private	Unknown	

Response received on 24th February 2009, from Stroud District Council

I have checked with colleagues in our Environmental Health team who deal with drainage issues and none of us are aware of any other coastal defences in private or council control. As far as I am aware, the defences that do exist in the District are in the control of the Environment Agency and I suggest you contact them in this regard.

Could you also note that three of the five place names are incorrectly spelt on your map. They should read as Bream, Berkeley and Frampton-on-Severn.

Regards

Peter Gilbert

Planning Strategy Manager

Stroud District Council

Tel: 01453 754305

Fax: 01453 754945

www.stroud.gov.uk

Enquiry to the Local Authority: **Vale of Glamorgan**

A unique code provided to each coastal defences asset - New references will be assigned by the Operating Authority (Environment Agency \ Local Authority)	Please provide engineering drawing reference	This data will be obtained from Operating Authorities : Environment Agency, Local Authority or Private	The design standard of the defence defined as a return period in years, if known	Any comment ?
Asset Reference	Engineering Drawing Reference	Maintainer	Design Standard	Comments
103HA90060101C02		Private	100	
103HA90070102C01		Private	Unknown	

Response received on 25th February 2009, from Vale of Glamorgan District Council

SFEwards@valeofglamorgan.gov.uk

Thank you for your email. The defences referred to are not private, but are owned and maintained by the Vale of Glamorgan Council. I attach a spreadsheet which indicates the location/type of defence structures in the Vale. Items 10 – 15 cover the Penarth area. I hope this is of use.

Regards

Steve.

Name of Local Authority: **Bristol**

A unique code provided to each coastal defences asset - New references will be assigned by the Operating Authority (Environment Agency \ Local Authority)	Please provide engineering drawing reference	This data will be obtained from Operating Authorities : Environment Agency, Local Authority or Private	The design standard of the defence defined as a return period in years, if known	Comments
Asset Reference	Engineering Drawing Reference	Maintainer	Design Standard	Comments
112GF22200201C02		private	100	
112GF22200201C04		private	100	
112GF22200201C06		private	100	

112GF22200101C01		private	100	
112GF22200101C02		private	100	
683/0405/02		private	99	

No response has been received yet.

Name of Local Authority: **Cardiff**

A unique code provided to each coastal defences asset - New references will be assigned by the Operating Authority (Environment Agency \ Local Authority)	Please provide engineering drawing reference	This data will be obtained from Operating Authorities : Environment Agency, Local Authority or Private	The design standard of the defence defined as a return period in years, if known	Any comment ?
Asset Reference	Engineering Drawing Reference	Maintainer	Design Standard	Comments
103HA90050301C03		private	100	
103HA90050301C04		private	200	
103HA90050301C05		private	200	
103HA90060101C01		private	200	
103HA90060101C02		private	100	

No change to the above has been received from Bristol CC.

Name of Local Authority: **Forest of Dean**

A unique code provided to each coastal defences asset - New references will be assigned by the Operating Authority (Environment Agency \ Local Authority)	Please provide engineering drawing reference	This data will be obtained from Operating Authorities : Environment Agency, Local Authority or Private	The design standard of the defence defined as a return period in years, if known	Comments
Asset Reference	Engineering Drawing Reference	Maintainer	Design Standard	Comments
032HA22220501C02		Private	Unknown	
032HA22220301B04		Private	Unknown	
032HA22220301C01		Local Authority	Unknown	

No change to the above has been received from Forest of Dean Council.

Name of Local Authority: **Monmouthshire**

A unique code provided to each coastal defences asset - New references will be assigned by the Operating Authority (Environment Agency \ Local Authority)	Please provide engineering drawing reference	This data will be obtained from Operating Authorities : Environment Agency, Local Authority or Private	The design standard of the defence defined as a return period in years, if known	Any comment ?
Asset Reference	Engineering Drawing Reference	Maintainer	Design Standard	Comments
103HA90030102C01		Private	Unknown	
103HA90030101C02		Private	Unknown	

No change to the above has been received from Monmouthshire CC.

Name of Local Authority: **Newport**

A unique code provided to each coastal defences asset - New references will be assigned by the Operating Authority (Environment Agency \ Local Authority)	Please provide engineering drawing reference	This data will be obtained from Operating Authorities : Environment Agency, Local Authority or Private	The design standard of the defence defined as a return period in years, if known	Any comment ?
Asset Reference	Engineering Drawing Reference	Maintainer	Design Standard	Comments
103HA90040201C01		private	Unknown	

Response received on 27th April, 2009, from Newport City Council.

Reply from Lindsay.Christian@newport.gov.uk with updates.

Thank you for your email. The defences referred to are not private, but are owned and maintained by the Vale of Glamorgan Council. I attach a spreadsheet which indicates

Name of Local Authority: **North Somerset**

A unique code provided to each coastal defences asset - New references will be assigned by the Operating Authority (Environment Agency \ Local Authority)	Please provide engineering drawing reference	This data will be obtained from Operating Authorities : Environment Agency, Local Authority or Private	The design standard of the defence defined as a return period in years, if known	Comments
Asset Reference	Engineering Drawing Reference	Maintainer	Design Standard	Comments
112GES8251003C03		local authority	50	
112GES8251004C01		private	100	
112GES8251004C02		local authority	50	
112GES8301001C01		private	100	
112GES8301002C01		local authority	50	
112GES8301003C02		private	50	
112GES8350501C03		private	100	
112GES8350501C04		private	100	
112GES8350502C01		private	5	
112GES8350502C03		private	100	
112GES8350502C04		private	100	
112GES8350503C01		private	5	
112GES8350504C01		private	100	
112GES8350504C02		private	100	
112GES8350504C03		private	100	
112GES8350504C04		private	100	
112GES8350504C06		private	100	
112GES8350504C07		private	100	
112GES8350505C02		private	100	
112GES8400501C02		private	100	
112GES8400501C08		private	100	
112GES8400501C11		private	100	
112GES8251002C01		local authority	50	
112GES8251003C01		local authority	100	
112GES8251003C02		local authority	50	
112GES8150502C01		local authority	100	
112GES8250504C08		private	200	
112GES8251001C02		private	200	

112GES8301005C02	private	50
112GES8350502C06	private	100
112GES8350504C05	private	100
112GES8350505C01	private	100
112GES8400501C06	private	100
683/0504/01	local authority	99
683/0505/01	local authority	99
683/0506/01	private	99
683/0507/01	private	99
683/0508/01	local authority	99
683/0509/01	local authority	99

Response received on 23rd February 2009, from North Somerset Council

John.Inman@n-somerset.gov.uk

As a result of a lack of resource my input into the NFCDD database has been virtually nil therefore to comment on the data you have sent me will not be possible. I will therefore have to agree with the data stated. If there is another way of checking this data please let me know.

Regards

John Inman

Principal Engineer (Drainage)
 Streets and Open Spaces
 Tele : 01934 - 427307.
 e-mail john.inman@n-somerset.gov.uk

Name of Local Authority: South Gloucestershire

A unique code provided to each coastal defences asset - New references will be assigned by the Operating Authority (Environment Agency \ Local Authority)	Please provide engineering drawing reference	This data will be obtained from Operating Authorities : Environment Agency, Local Authority or Private	The design standard of the defence defined as a return period in years, if known	Any comment ?
Asset Reference	Engineering Drawing Reference	Maintainer	Design Standard	Comments

112GF22200201C06		private	100	
112GF22200202C01		private	100	
112GF22200301C05		local authority	100	
112GF22200301C06		private	100	
112GF22200301C07		local authority	100	
112GF22200301C08		local authority	100	
112GF22200301C09		local authority	100	
112GF22200301C10		local authority	100	
112GF22200901C07		private	200	
112GF22200901C09		private	1000	
112GF22201001C01		private	1000	
112GF22201001C02		private	1000	
112GF22201001C03		private	1000	
112GF22201001C04		private	1000	
112GF22200202C02		private	100	
112GF22200202C03		private	100	
112GF22200501C02		private	200	
112GF22200602C01		local authority	200	
112GF22201001C05		private	1000	
112GF22201001C06		private	1000	
112GF22201001C07		private	1000	
683/0301/01		private	99	

No change to the above has been received from South Gloucestershire Council.

PART C - Develop Baseline Scenarios

1. Aim of this Part

The scenario analysis for the Severn Estuary SMP2 aims to provide an appreciation of how the shoreline is behaving and the influence that shoreline management policy may have upon its behaviour over time. This is the basis upon which flood and coastal erosion risks are determined.

The development and appraisal of policy scenarios will be developed from this baseline scenario analysis.

1.1. Approach

The scenario analysis provides an understanding of coastal evolution along the Severn Estuary Shoreline in response to baseline scenarios of coastal management:

- 'No Active Intervention';
- 'With Present Management'.

The data to guide the analysis is provided by our understanding of coastal behaviour and dynamics both historically and present day. Data on future shoreline has been gathered from the Severn Estuary FRM Strategy, Severn Estuary SMP1, Severn Estuary CHaMP and Futurecoast studies, as well as regional and scheme levels studies such as the Gwent Levels FMP, Rumney Great Wharf FDS and Avonmouth to Aust Tidal Defence Strategy.

The analysis takes into account changing wider scale hydrodynamic and geomorphological processes in order to predict the response of the shoreline over the 3 epochs of 0-20 year, 20-50 years and 50-100 years. For each policy scenario the following has been identified:

- What the shoreline will look like (feature characteristics i.e. morphology and sedimentology);
- Where the shoreline will be (position);
- What has caused the change to occur;
- What the impacts are along the coast to identified features.

1.2. Baseline Scenarios

No Active Intervention (NAI)

The 'No Active Intervention' assessment assumes that defences are not maintained.

The effectiveness of the defences will change across each time period as some fail sooner than others, depending on their residual life. In order to make an assessment of residual life of defences, the type of defence, condition and material will be noted by the assessment.

Appraisals include consideration of climate change and discuss shoreline response (both in terms of how the shoreline will look and where it will be) for each of the three epochs.

The NAI interpretation is mapped and included in Annex B.

With Present Management (WPM)

The 'With Present Management' assessment of the shoreline will consider the policies in place that guide the current management practices (as set by the SMP1).

The assessment will identify lengths of coast where, due to altering coastal processes (e.g. rising relative sea levels), current levels of maintenance on defences may become ineffective at managing the risk of flooding and/or erosion and where more significant management regimes would be needed to maintain their integrity and effectiveness.

Where the underlying policy is 'Hold the Line' then the current defence is sustained (i.e. maintain current day Standard of Protection (SoP) of 1% AEP) for the length of coast. If the underlying SMP1 policy is 'Do Nothing', then it is assumed that NAI is the current practice, so the defence lasts as long as it's residual life and then fails. Details on the SMP1 policies are presented at the end of this Part.

Using this interpretation, we can describe how the shore or any beach / saltmarsh, etc. in front of the current line of defence will change under the current practice.

The WPM interpretation is mapped and included in Annex C.

Understanding the Maps

This section is a guide to help understand the No Active Intervention and With Present Management maps.

The maps show the tidal flooding and erosion expected at the shoreline considered by the SMP2 over the 3 epochs; 0-20 years, 20-50 and 50 to 100years. The movement of the shoreline or flood extent is mapped from **Mean High Water Springs (MHWS)** (see Main Report for definition of MHWS).

Text boxes have been added to NAI maps where localised detail is not mapped.

1.3. Climate Change and Sea Level Rise

Alterations to relative sea level can have implications for the shoreline management. The modern day shoreline is heavily populated with human settlements including hard structures that cannot easily be moved to suit the adjustments to relative sea level.

It is generally recognised that the global climate is changing, with implications for sea level and the storminess of the climate. Changes to global sea level (eustatic change) are influenced by climatic changes as temperature rise results in increased volume of water through thermal expansion and melting ice. Evidence suggests that global average sea level rose by about 1.5mm/year during the twentieth century (after natural land movements); this is believed to be due to a number of factors including thermal expansion of warming ocean waters and the melting of land glaciers.

The South of England is currently undergoing changes to the land level (isostatic), the land rebounding from glacial cover over 10,000 years before present. The Severn Estuary shoreline has been subsiding at a rate of 0.2 to 0.5mm per year (Shennan and Horton, 2002), this trend of subsidence is expected to continue over the next 100years.

The anticipated changes have implications for the management of future coast, but there remains considerable uncertainty both within the science of future climate modelling and the impact on shoreline management.

The **UK Climate Impacts Programme scenarios (UKCIP02)** suggest that by 2080 the sea level will rise by between 20cm and 80cm in the South West and by about 40cm around Wales. Formal guidance on UKCIP02 was issued by Defra in 2006 and WAG in 2007.

The UKCIP02 predictions have recently been updated by the **UK Climate Projections 2009 (UKCP09)**, which estimate sea level rises between 37cm and 53cm in England and Wales.

Due to the timing of UKCP09 publications, the SMP2 used UKCIP02 predictions as applied in Defra (2006) and WAG (2007). The UKCP09 sea level rise predictions are either less than or similar to the Defra (2006) and WAG (2007) guidance, dependent on which emissions scenario is chosen.

The change in MHWS has been calculated using the Defra (2006) and WAG (2007) formal guidance for sea level rise and information on the height of the land. This has been plotted on a

map to show what would happen if current defences were not maintained, repaired or replaced. This is the **No Active Intervention** scenario.

Assumed Vertical Land Movement (mm/yr)	Net Sea Level Rise (mm/yr)			
	1990 - 2025	2025 - 2055	2055 - 2085	2085 - 2115
-0.5	3.5	8.0	11.5	14.5

(Source: after Defra, 2006)

1.4. The Severn Bore

The Severn Tidal Bore is a large surge wave that is experienced in the Severn Estuary. The phenomenon is generated in the Upper Severn Estuary as the water is funnelled into the increasingly narrow and shallow channel as the tide rises, thus forming the wave.

Tidal bores form at high tide, and are most prominent in when the tidal range is greatest (Kirby and Shaw, 2004). The height of the bore is dependent on factors such as wind strength and direction, and freshwater levels (Higgins, 2007). When there is a high level of freshwater in the Upper Severn Estuary the bore height is decreased, therefore counteracting potential increased flood risk. However, in the event of overtopping, saturated soils due to adverse weather conditions can lead to flooding on the fields adjacent to the estuary as occurred in February, 2009 (BBC, 2009).

The increased tidal flood risk, nor in addition to fluvial flood risk, caused by the tidal bore is not documented, and therefore has not been included in the baseline scenario flood risk mapping.

Baseline Case 1 – No Active Intervention

Baseline Scenario 1 – No Active Intervention						
	Predicted Change for:					
Location	Years 0 – 20 (2025)		Years 20 – 50 (2055)		Years 50 – 100 (2105)	
	Defences	Natural Coast	Defences	Natural Coast	Defences	Natural Coast
Penarth						
Lavernock Point to Penarth Esplanade	The concrete and masonry sea wall alongside Cliff Hill will remain in place. High ground prevents flood risk.	There has been little change in the cliff position over the past 100 years, and this is expected to continue. Flattening of the foreshore is expected.	The concrete and masonry wall is expected to remain in place, although its condition will deteriorate significantly. High ground prevents flood risk.	Cliff erosion rates are expected to increase marginally where not protected, due to sea level rise and greater storminess. The foreshore will continue to flatten and erode.	The concrete and masonry wall are expected to fail in this period. High ground prevents flood risk.	Cliff erosion rates will continue to increase, with the now unprotected section also eroding more rapidly. Erosion would be punctuated by significant cliff falls rather than continual erosion. The foreshore will continue to flatten and erode.
Penarth Esplanade: Cliff Road to The Kymin	Penarth Esplanade seawall will deteriorate and fail during this period. High ground prevents tidal flood risk, although nuisance wave overtopping could occur.	The shoreline position will be maintained by the seawall. The low lying foreshore, whilst sheltered from the dominant wave direction, is predicted to flatten.	Penarth Esplanade seawall will have failed in this period. High ground prevents tidal flood risk, although significant wave overtopping could occur.	The shoreline position will be maintained by the seawall. The low lying foreshore, whilst sheltered from the dominant wave direction, is predicted to flatten.	Penarth Esplanade seawall will have failed in this period. High ground prevents tidal flood risk, although wave overtopping could occur.	The shoreline position will evolve towards its natural location. The low lying foreshore, whilst sheltered from the dominant waves, will be vulnerable to erosion.
Penarth Head	The groyne system to the north will	The cliff position has moved	The failed groyne system will not fulfil	The cliff will retreat at an increased	The failed groyne system will not fulfil	The cliff will retreat at an accelerated rate

Baseline Scenario 1 – No Active Intervention						
	Predicted Change for:					
Location	Years 0 – 20 (2025)		Years 20 – 50 (2055)		Years 50 – 100 (2105)	
	Defences	Natural Coast	Defences	Natural Coast	Defences	Natural Coast
	deteriorate and fail in this period. High ground prevents flood risk.	landward by 0.1m/year; this trend is expected to continue. Beach loss will begin to occur.	its function. High ground prevents flood risk.	rate due to partial loss of the beach, sea level rise and greater storminess.	its function. High ground prevents flood risk.	due to complete loss of the beach, sea level rise and greater storminess.
Cardiff Area						
Cardiff Bay Barrage	Cardiff Bay Barrage is expected to maintain the existing shoreline. The high crest level of Cardiff Bay Barrage will prevent flooding.	The natural siltation of the Taff and Ely estuary will establish natural conditions at the foreshore after navigational dredging.	Cardiff Bay Barrage is expected to maintain the existing shoreline. The high crest level of Cardiff Bay Barrage will prevent flooding.	The natural siltation of the Taff and Ely estuary will establish natural conditions at the foreshore after navigational dredging.	Cardiff Bay Barrage, whilst deteriorating, will maintain the shoreline position.	The natural siltation of the foreshore will continue.
Cardiff Flats to Pengam Moor	The rock armouring will deteriorate and fail in this period. Relatively high made ground levels limit flood risk.	Historic erosion of the shoreline and foreshore will continue.	The failed rock armouring will have some residual function in this period. Relatively high made ground levels limit flood risk.	Erosion of the shoreline and foreshore will accelerate.	The failed rock armouring will not provide protection. Relatively high made ground levels limit flood risk.	Erosion of the shoreline and foreshore will accelerate.
River Rhymney	The mixture of defences are expected to deteriorate and some fail. Embankment	The mixture of defences, where adjacent to the river, will hold the banks in place.	The mixture of defences are expected to have failed by this period. Embankment breach will occur under the	The River Rhymney banks will be able to meander naturally.	Failure of the defences would result in critical flood risk.	Complete failure of the earth embankments will allow the River Rhymney to meander

Baseline Scenario 1 – No Active Intervention						
	Predicted Change for:					
Location	Years 0 – 20 (2025)		Years 20 – 50 (2055)		Years 50 – 100 (2105)	
	Defences	Natural Coast	Defences	Natural Coast	Defences	Natural Coast
	breach will occur in the 0.5% AEP (annual expected probability) event: flood risk is limited.		10% AEP event: flood risk is significant.			naturally.
Wentlooge						
Rumney Great Wharf	Earth embankment and rock armouring will remain in place. The polder field will deteriorate but still function. Embankment breach will occur in the 0.5% AEP flood event; flood risk is limited.	Historical foreshore retreat of circa 2m/year will be halted due to rock armouring. Fronting mudflats will continue to lower.	Embankment and rock armouring will begin to fail in this period. The polder field are expected to fail completely. Embankment breach will occur under the 2% flood AEP event: flood risk is medium.	The foreshore will continue to steepen. The mudflats will continue to lower and saltmarsh will erode significantly.	Complete failure of the embankment, and continued erosion is expected. Regular flooding of the Wentlooge Levels would occur.	The mudflats will undergo significant lowering, with the eroding saltmarsh losing its coherence. The shoreline will migrate inland. MHWS (Mean high water springs) will be located at the back of the floodplain.
Peterstone Great Wharf	Earth embankment and historically stable, rock armoured, saltmarsh will remain in place. Breach will occur in the event of the 10% AEP flood occurring: significant flood	The rock armouring will maintain the shoreline position, with steepening and lowering of the mudflats. Breach of low section of defence would occur in extreme events.	Embankment and rock armoured saltmarsh are expected to fail more widely in this period. Breach will occur in the event of the 20% AEP flood occurring: significant flood risk.	The foreshore will continue to steepen. The mudflats will continue to lower and saltmarsh will erode significantly.	Complete failure of the embankment, and continued erosion, is anticipated. Regular flooding of the Wentlooge Levels would occur.	The mudflats will undergo significant lowering, with the eroding saltmarsh losing its coherence. The shoreline will migrate inland. MHWS (Mean high water springs) will be located at the back of the floodplain.

Baseline Scenario 1 – No Active Intervention						
	Predicted Change for:					
Location	Years 0 – 20 (2025)		Years 20 – 50 (2055)		Years 50 – 100 (2105)	
	Defences	Natural Coast	Defences	Natural Coast	Defences	Natural Coast
	risk.					
Peterstone Gout to east of Outfall Lane	The armoured embankment is expected to remain in place. Breach will occur in the event of the 0.1% AEP significant flood event: limited flood risk.	Historically stable saltmarsh will recede at a rate of 0.1m/year, with steepening and lowering of the mudflats.	The armoured embankment will begin to fail in this period. Breach will occur in the event of the 0.1% AEP significant flood event: limited flood risk.	The saltmarsh will recede at a rate of 0.1m/year, with steepening and lowering of the mudflats.	The armoured embankments are expected to fail during this period. Regular flooding of the Wentlooge Levels would occur.	The saltmarsh will recede at an accelerated rate, with steepening and lowering of the mudflats. MHWS (Mean high water springs) will be located at the back of the floodplain.
East of Outfall Lane to River Ebbw (west bank)	The armoured embankment is expected to remain in place. Breach will occur in the event of the 0.1% AEP significant flood event: limited flood risk.	Historically stable saltmarsh will recede at a rate of 0.1m/year, with steepening and lowering of the mudflats.	The armoured embankment will begin to fail in this period. Breach will occur in the event of the 0.1% AEP significant flood event: limited flood risk.	The saltmarsh will recede at a rate of 0.1m/year, with steepening and lowering of the mudflats.	The armoured embankments are expected to fail during this period. Regular flooding of the Wentlooge Levels would occur.	The saltmarsh will recede at an accelerated rate, with steepening and lowering of the mudflats. MHWS (Mean high water springs) will be located at the back of the floodplain.
Newport Area and the River Usk						
Ebbw River to the Transporter Bridge (right bank)	The earth embankments will deteriorate and fail in this period. Regular flooding will occur although	The channel cuts through Devonian sandstone and mudstone. This has been historically stable and is	The failed earth embankments will allow regular flooding although constrained by relatively high ground.	The channel cuts through Devonian sandstone and mudstone. This has been historically stable and is	The failed earth embankments will allow regular flooding: this will result in a high level of flood risk due to	Although the channel has historically been stable, meandering of the river could occur.

Baseline Scenario 1 – No Active Intervention						
	Predicted Change for:					
Location	Years 0 – 20 (2025)		Years 20 – 50 (2055)		Years 50 – 100 (2105)	
	Defences	Natural Coast	Defences	Natural Coast	Defences	Natural Coast
	constrained by relatively high ground.	expected to continue.		expected to continue.	sea level rise.	
Transporter Bridge to the M4 motorway (right bank)	The earth embankments and masonry walls will deteriorate and fail in this period. Regular flooding will occur.	The channel cuts through Devonian sandstone and mudstone. This has been historically stable and is expected to continue. MHWS will be located landward at the back of the floodplain.	The failed earth embankments and masonry walls will allow regular flooding.	The channel cuts through Devonian sandstone and mudstone. This has been historically stable and is expected to continue. MHWS will be located landward at the back of the floodplain.	The failed earth embankments and masonry walls will allow regular flooding.	Although the channel has historically been stable, meandering of the river could occur. MHWS will be located landward at the back of the floodplain.
M4 motorway to Newbridge on Usk (both banks)	The earth embankments will deteriorate and fail in this period, with deterioration of the masonry walls also. Regular but spatially constrained flooding will occur.	The channel cuts through Devonian sandstone and mudstone. This has been historically stable and is expected to continue. MHWS will be located landward at the back of the floodplain.	The masonry walls are expected to fail in this period, allowing regular but spatially constrained flooding.	The channel cuts through Devonian sandstone and mudstone. This has been historically stable and is expected to continue.	The failed earth embankments and masonry walls will allow regular but spatially constrained flooding.	Although the channel has historically been stable, meandering of the river could occur.
M4 motorway to Spytty Pill (left	The earth embankments will	The channel cuts through Devonian	The reinforced concrete walls are	The channel cuts through Devonian	The failed earth embankments and	Although the channel has historically been

Baseline Scenario 1 – No Active Intervention						
	Predicted Change for:					
Location	Years 0 – 20 (2025)		Years 20 – 50 (2055)		Years 50 – 100 (2105)	
	Defences	Natural Coast	Defences	Natural Coast	Defences	Natural Coast
bank)	deteriorate and fail in this period, with deterioration of the reinforced concrete walls also. Regular but spatially constrained flooding will occur.	sandstone and mudstone. This has been historically stable and is expected to continue. MHWS will be located landward at the back of the floodplain.	expected to fail in this period, allowing regular but spatially constrained flooding.	sandstone and mudstone. This has been historically stable and is expected to continue.	reinforced concrete walls will allow regular but spatially constrained flooding.	stable, meandering of the river could occur.
Spytty Pill to Uskmouth Power Station (left bank)	The earth embankment will deteriorate and fail in this period. Regular widespread flooding will occur through to the Caldicot Levels.	The channel cuts through Devonian sandstone and mudstone. This has been historically stable and is expected to continue. MHWS will be located landward at the back of the floodplain.	The failed earth embankment will allow regular widespread flooding to occur through to the Caldicot Levels.	The channel cuts through Devonian sandstone and mudstone. This has been historically stable and is expected to continue. MHWS will be located landward at the back of the floodplain.	The failed earth embankment will allow regular widespread flooding to occur through to the Caldicot Levels.	Although the channel has historically been stable, meandering of the river could occur. MHWS will be located landward at the back of the floodplain.
Uskmouth Power Station (AES Fifoots PS) to Saltmarsh Farm	The revetment with wave wall will remain in place in this period. Breach will occur in the event of the 0.1% AEP significant	The existing shoreline position will remain, although the foreshore will continue to lower.	The revetments with wave wall are expected to fail during this period. Breach will occur in the event of the 0.1% AEP significant flood	The existing shoreline position will remain, although the foreshore will continue to lower. MHWS will be	The revetment with wave wall will have failed in this period and allow regular widespread flooding to occur through to the Caldicot Levels.	The shoreline will migrate inland. MHWS will be located at the back of the floodplain.

Baseline Scenario 1 – No Active Intervention						
	Predicted Change for:					
Location	Years 0 – 20 (2025)		Years 20 – 50 (2055)		Years 50 – 100 (2105)	
	Defences	Natural Coast	Defences	Natural Coast	Defences	Natural Coast
	flood event: limited flood risk.		event: limited flood risk.	located at the back of the floodplain.		
Saltmarsh Farm to Gold Cliff	The concrete revetment with rock armouring will remain in place in this period, although the system of four stone groynes will deteriorate. Breach will occur in the event of the 0.1% AEP significant flood event: limited flood risk.	The historic shoreline retreat rate of 1m/year is expected to continue.	The concrete revetment with rock armouring will deteriorate and eventually fail in this period, along with the system of four stone groynes. Breach will occur in the event of the 0.1% AEP significant flood event: limited flood risk.	The historic retreat rate of 1m/year is expected to accelerate. MHWS will be located at the back of the floodplain.	The concrete revetment with rock armouring will have failed in this period and allow regular widespread flooding to occur through to the Caldicot Levels.	Historic retreat rate of 1m/year is expected to further accelerate. MHWS will be located landward at the back of the floodplain.
Caldicot Levels						
Gold Cliff to West Pill	The earth embankment with rock armouring/concrete revetment will remain in place in this period. Breach will occur in the event of the 0.1% AEP significant flood event: limited	The historical trend of mudflat erosion with relatively stable upper saltmarsh will continue.	The earth embankment with rock armouring/concrete revetment will deteriorate and eventually fail in this period. Breach will occur in the event of the 2% AEP significant flood event: medium flood	The continued mudflat erosion will result in increased exposure promoting significant erosion of the upper saltmarsh. MHWS will be located at the back of the floodplain.	The earth embankment with concrete revetment/rock armouring will have failed in this period and allow regular widespread flooding to occur through to the Caldicot Levels.	Continued erosion will result in large scale loss of the upper saltmarsh. MHWS will be located landward at the back of the floodplain.

Baseline Scenario 1 – No Active Intervention						
	Predicted Change for:					
Location	Years 0 – 20 (2025)		Years 20 – 50 (2055)		Years 50 – 100 (2105)	
	Defences	Natural Coast	Defences	Natural Coast	Defences	Natural Coast
	flood risk.		risk.			
West Pill to West of Sudbrook Point	The earth embankment with rock armouring is expected to remain in place. Breach will occur under the 0.5% AEP flood event: limited flood risk.	The historical trend of marginal saltmarsh accretion is expected to continue.	The earth embankment with rock armouring will deteriorate and eventually fail in this period. Breach will occur in the event of the 5% AEP flood occurring: medium flood risk.	Accretion is expected to slow and reverse due to accelerated sea level rise. MHWS will be located landward at the back of the floodplain.	The earth embankment with rock armouring will have failed in this period and allow regular widespread flooding to occur through to the Caldicot Levels.	Continued erosion of the saltmarsh is predicted to occur. MHWS will be located landward at the back of the floodplain.
Sudbrook Point to Black Rock	The rock armour and groyne system are expected to fail in this period. High ground precludes flooding.	The Old Red Sandstone headland at Sudbrook is predicted to remain stable or slowly erode.	The rock armour and groyne system will have lost its function in this period. High ground precludes flooding.	The Old Red Sandstone headland at Sudbrook is predicted to slowly erode.	Complete failure of the rock armour and groyne system. High ground precludes flooding.	Shoreline retreat rates will increase due to accelerated climate change.
Black Rock to Thornwell	The rock armoured and earth embankments are expected to remain in place. Breach will occur under the 0.5% AEP flood event: limited flood risk.	The foreshore is expected to flatten.	The rock armoured and earth embankments will deteriorate and eventually fail in this period. Breach will occur under the 5% AEP flood event: high flood risk.	The shoreline will begin to retreat. MHWS will be located landward at the back of the floodplain.	Complete failure of the rock armoured and earth embankments, with regular widespread flooding.	The shoreline will begin to retreat. MHWS will be located landward at the back of the floodplain.
Beachley Point	No defences; high	Hard geology cliff	No defences; high	Hard geology cliff	No defences; high	Hard geology cliff will

Baseline Scenario 1 – No Active Intervention						
	Predicted Change for:					
Location	Years 0 – 20 (2025)		Years 20 – 50 (2055)		Years 50 – 100 (2105)	
	Defences	Natural Coast	Defences	Natural Coast	Defences	Natural Coast
	ground prevents flood risk.	will remain stable.	ground prevents flood risk.	will remain stable.	ground prevents flood risk.	remain stable.
Chepstow, the River Wye and surrounding Area						
Thornwell to Alcove Wood (right bank)	The flood defences at Chepstow will remain in place. Breach will occur under the 0.5% AEP flood event: limited flood risk.	Hard geology river will remain stable.	The flood defences at Chepstow will deteriorate and fail in this period. Breach will occur under the 1% AEP flood event: limited flood risk.	Hard geology river will remain stable.	The flood defences will have failed in this period, allowing regular but spatially constrained flooding.	Hard geology river will remain stable.
Alcove Wood-Chapel House Wood to Tintern Abbey (both banks)	General high ground prevents flood risk except at Tintern.	Hard geology river will remain stable.	General high ground prevents flood risk except at Tintern.	Hard geology river will remain stable.	General high ground prevents flood risk except at Tintern.	Hard geology river will remain stable.
Chapel House Wood to Sedbury Sewage Works (left bank)	General high ground prevents flood risk.	Hard geology river will remain stable.	General high ground prevents flood risk.	Hard geology river will remain stable.	General high ground prevents flood risk.	Hard geology river will remain stable.
Sedbury Sewage Works to north Beachley (left bank)	Spatially constrained flooding.	Hard geology river will remain stable.	Spatially constrained flooding.	Hard geology river will remain stable.	Spatially constrained flooding.	Hard geology river will remain stable.
Chepstow to Lydney						
Beachley to Pillhouse Rocks	Predominantly high ground, with embankment at	Cliff will remain stable.	Predominantly high ground, with failed embankment at	Cliff will remain stable.	Predominantly high ground, with embankment at	Cliff will remain stable.

Baseline Scenario 1 – No Active Intervention						
	Predicted Change for:					
Location	Years 0 – 20 (2025)		Years 20 – 50 (2055)		Years 50 – 100 (2105)	
	Defences	Natural Coast	Defences	Natural Coast	Defences	Natural Coast
	Sturch Pill eventually failing. Breach will occur under the 0.5% AEP event: limited flood risk.		Sturch Pill. Regular flooding of constrained floodplain.		Sturch Pill failing in this period. Regular flooding of constrained floodplain.	
Pillhouse Rocks to Guscar Rocks	Railway embankment with failed tide flaps, and intermittent high ground. Constrained flooding occurs during extreme events.	Variable erosion and accretion of the shoreline region will continue.	Railway embankment with failed tide flaps, and intermittent high ground. Constrained flooding occurs during extreme events.	Erosional processes will become dominant, with slow retreat of the shoreline (0.1m/year).	Railway embankment with failed tide flaps, and intermittent high ground. Constrained flooding occurs during extreme events.	Erosional processes will become dominant, with slow retreat of the shoreline (0.1m/year).
Lydney						
Guscar Rocks to/and Lydney Harbour	The rock armoured embankment will remain in place. Breach will occur under the 0.1% AEP event: limited flood risk.	Significant variation in erosion/accretion (up to 8m/year locally at Cone Pill) will continue.	The rock armoured embankment will deteriorate and fail towards the end of this period. Breach will occur under the 5% AEP event: medium flood risk.	Erosional processes will become dominant, with slow retreat of the shoreline (0.1m/year).	Complete failure of the rock armoured embankment, with regular flooding.	Erosional processes at the shoreline will result in landward migration of the shoreline. MHWS will be located landward at the back of the floodplain.
Lydney to Gloucester						
Lydney Harbour to Wellhouse Rock	The railway retaining wall and embankment will	The mudstone cliffs will remain stable.	The railway retaining wall and embankment will	The mudstone cliff will undergo limited	The railway retaining wall and embankment will	The mudstone cliff will undergo limited

Baseline Scenario 1 – No Active Intervention						
	Predicted Change for:					
Location	Years 0 – 20 (2025)		Years 20 – 50 (2055)		Years 50 – 100 (2105)	
	Defences	Natural Coast	Defences	Natural Coast	Defences	Natural Coast
(right bank)	remain in place. Breach will occur under the 0.5% AEP event: limited flood risk.		deteriorate and eventually fail during this period. Limited flood risk.	erosion.	have failed in this period, although flood risk will be limited.	erosion.
Wellhouse Rock to Poulton Court (right bank)	The railway retaining wall will remain in place. Limited flood risk.	The mudstone cliffs will remain stable.	The railway retaining wall will deteriorate and fail in this period, with limited flood risk.	The mudstone cliff will undergo limited erosion.	The failed railway retaining wall will allow limited flood risk.	The mudstone cliff will undergo limited erosion.
Poulton Court to Whitescourt (right bank)	The earth embankment will deteriorate and fail in this period. Breach will occur under the 5% AEP event: high flood risk.	The mudstone cliffs will remain stable.	The failed earth embankment will allow regular but constrained flooding. MHWS would be located at the back of the floodplain.	The mudstone cliff will undergo limited erosion.	The failed earth embankment will allow regular but constrained flooding. MHWS would be located at the back of the floodplain.	The mudstone cliff will undergo limited erosion.
Whitescourt to Northingham Farm (right bank)	The embankments with some masonry protection will deteriorate and fail in this period. Breach of the defences will occur in the event of the 20% AEP flood: significant flood risk.	Erosion will continue at the coast resulting in a migration of the shoreline inland. MHWS would be located at the back of the floodplain.	Complete failure of the embankments would allow regular flooding.	The rate of erosion at the shoreline will accelerate. MHWS would be located at the back of the floodplain.	Complete failure of the embankments would allow regular flooding.	The rate of erosion at the shoreline will accelerate. MHWS would be located at the back of the floodplain.

Baseline Scenario 1 – No Active Intervention						
	Predicted Change for:					
Location	Years 0 – 20 (2025)		Years 20 – 50 (2055)		Years 50 – 100 (2105)	
	Defences	Natural Coast	Defences	Natural Coast	Defences	Natural Coast
Northington Farm to Newnham (right bank)	The earth embankments will deteriorate and fail towards the end of this period. Breach of the defences will occur under the 5% AEP event, with constrained flooding.	Erosion will continue at the coast resulting in a migration of the shoreline inland.	The earth embankments are expected to fail during this period, with constrained flooding.	The rate of erosion at the shoreline will accelerate as a result of sea level rise.	Complete failure of the embankments, with constrained flooding.	The rate of erosion at the shoreline will accelerate.
Newnham to Broadoak (right bank)	The earth embankment and flood walls will deteriorate and fail during this period. Breach of the defences will occur under the 5% AEP event, with constrained flooding.	Erosion will continue at the coast resulting in a migration of the shoreline inland.	The earth embankment and flood walls will have failed during this period, with constrained flooding.	The rate of erosion at the shoreline will accelerate as a result of sea level rise.	Complete failure of the embankment and flood walls, with constrained flooding.	The rate of erosion at the shoreline will accelerate.
Broadoak to Garden Cliff (right bank)	The earth embankments will deteriorate and fail during this period. Breach of the defences will occur under the 5% AEP event: significant	Erosion will continue at the coast resulting in a migration of the shoreline inland. MHWS would be located at the back of the floodplain.	The earth embankments will have failed during this period, with regular flooding.	The rate of erosion at the shoreline will accelerate as a result of sea level rise. MHWS would be located at the back of the floodplain.	Complete failure of the embankments, with regular flooding.	The rate of erosion at the shoreline will accelerate. MHWS would be located at the back of the floodplain.

Baseline Scenario 1 – No Active Intervention						
	Predicted Change for:					
Location	Years 0 – 20 (2025)		Years 20 – 50 (2055)		Years 50 – 100 (2105)	
	Defences	Natural Coast	Defences	Natural Coast	Defences	Natural Coast
	flood risk.					
Garden Cliff to Rodley (right bank)	The earth embankments will deteriorate and fail during this period. Breach of the defences will occur under the 5% AEP event.	Erosion will continue at the coast resulting in a migration of the shoreline inland. MHWS would be located at the back of the floodplain.	The earth embankments will have failed in this period, with regular flooding.	The rate of erosion at the shoreline will accelerate as a result of sea level rise. MHWS would be located at the back of the floodplain.	Complete failure of the embankments, with regular flooding.	The rate of erosion at the shoreline will accelerate. MHWS would be located at the back of the floodplain.
Rodley to Bollow (right bank)	No defences: high ground.	Erosion will continue at the coast resulting in a migration of the shoreline inland.	No defences: high ground.	The rate of erosion at the shoreline will accelerate as a result of sea level rise.	No defences: high ground.	The rate of erosion at the shoreline will accelerate.
Bollow to Walmore Common (right bank)	The earth embankments will deteriorate during this period. Breach of the defences will occur under the 1% AEP event.	Erosion will continue at the coast resulting in a migration of the shoreline inland.	The earth embankments are expected to fail during this period, with regular flooding.	The rate of erosion at the shoreline will accelerate as a result of sea level rise. MHWS would be located at the back of the floodplain.	Complete failure of the embankments, with regular flooding.	The rate of erosion at the shoreline will accelerate. MHWS would be located at the back of the floodplain.
Walmore Common to Oakle Street (right bank)	The earth embankments and flood walls will deteriorate during this period. Breach of the defences will	Erosion will continue at the coast resulting in a migration of the shoreline inland.	The earth embankments and flood walls are expected to fail during this period, with regular flooding.	The rate of erosion at the shoreline will accelerate as a result of sea level rise. MHWS would be located at the	Complete failure of the embankments and flood walls, with regular flooding.	The rate of erosion at the shoreline will accelerate. MHWS would be located at the back of the floodplain.

Baseline Scenario 1 – No Active Intervention						
	Predicted Change for:					
Location	Years 0 – 20 (2025)		Years 20 – 50 (2055)		Years 50 – 100 (2105)	
	Defences	Natural Coast	Defences	Natural Coast	Defences	Natural Coast
	occur under the 5% AEP event: significant flood risk.			back of the floodplain.		
Oakle Street to Highcross Farm (right bank)	The earth embankments will deteriorate and fail towards the end of this period. Breach of the defences will occur under the 10% AEP event: significant flood risk.	Erosion will continue at the coast resulting in a migration of the shoreline inland.	The earth embankments are expected to fail during this period, with regular flooding.	The rate of erosion at the shoreline will accelerate as a result of sea level rise. MHWS would be located at the back of the floodplain.	Complete failure of the embankments, with regular flooding.	The rate of erosion at the shoreline will accelerate. MHWS would be located at the back of the floodplain.
Highcross Farm to Over Bridge (right bank)	The earth embankments will deteriorate and fail towards the end of this period. Breach of the defences will occur under the 10% AEP event: significant flood risk.	Erosion will continue at the coast resulting in a migration of the shoreline inland.	The earth embankments are expected to fail during this period, with regular flooding.	The rate of erosion at the shoreline will accelerate as a result of sea level rise. MHWS would be located at the back of the floodplain.	Complete failure of the embankments, with regular flooding.	The rate of erosion at the shoreline will accelerate. MHWS would be located at the back of the floodplain.
Over Bridge to Maisemore Weir (right bank, west channel of The)	The earth embankments will deteriorate and fail towards the end of this period. Breach	Erosion will continue at the coast resulting in a migration of the	The earth embankments are expected to fail during this period, with constrained	The rate of erosion at the shoreline will accelerate as a result of sea level	Complete failure of the embankments, with constrained flooding.	The rate of erosion at the shoreline will accelerate.

Baseline Scenario 1 – No Active Intervention						
	Predicted Change for:					
Location	Years 0 – 20 (2025)		Years 20 – 50 (2055)		Years 50 – 100 (2105)	
	Defences	Natural Coast	Defences	Natural Coast	Defences	Natural Coast
Partings)	of the defences will occur under the 10% AEP event: significant flood risk.	shoreline inland.	flooding.	rise.		
Gloucester to Haw Bridge						
Maisemore Weir to Ashleworth (right bank)	The earth embankments will deteriorate and fail towards the end of this period. Flooding will occur under the 100% AEP event: significant flood risk.	Erosion will continue at the coast resulting in a migration of the shoreline inland.	The earth embankments are expected to fail during this period, with constrained flooding.	The rate of erosion at the shoreline will accelerate as a result of sea level rise.	Complete failure of the embankments, with constrained flooding.	The rate of erosion at the shoreline will accelerate.
Ashleworth to Haw Bridge (right bank)	The earth embankments will deteriorate and fail towards the end of this period. Flooding will occur above 5% AEP events: significant flood risk.	Erosion will continue at the coast resulting in a migration of the shoreline inland.	The earth embankments are expected to fail during this period, with regular flooding.	The rate of erosion at the shoreline will accelerate as a result of sea level rise.	Complete failure of the embankments, with regular flooding.	The rate of erosion at the shoreline will accelerate.
Alney Island (Inner banks of The Partings)	The flood walls will deteriorate and fail in this period.	Erosion will continue at the coast resulting in a	The flood walls are expected to fail during this period,	The rate of erosion at the shoreline will accelerate as a	Complete failure of the flood walls, with regular flooding.	The rate of erosion at the shoreline will accelerate.

Baseline Scenario 1 – No Active Intervention						
	Predicted Change for:					
Location	Years 0 – 20 (2025)		Years 20 – 50 (2055)		Years 50 – 100 (2105)	
	Defences	Natural Coast	Defences	Natural Coast	Defences	Natural Coast
	Flooding will occur under the 10% to 100% AEP event: significant flood risk.	migration of the shoreline inland.	with regular flooding.	result of sea level rise.		
Haw Bridge to Ashleworth (left bank)	The earth embankments will deteriorate and fail towards the end of this period. Flooding will occur above 5% AEP events: significant flood risk.	Erosion will continue at the coast resulting in a migration of the shoreline inland.	The earth embankments are expected to fail during this period, with regular flooding.	The rate of erosion at the shoreline will accelerate as a result of sea level rise.	Complete failure of the embankments, with regular flooding.	The rate of erosion at the shoreline will accelerate.
Ashleworth to Llanthony Weir (left bank)	The earth embankments will deteriorate and fail towards the end of this period. Flooding will occur above 5% AEP events: significant flood risk.	Erosion will continue at the coast resulting in a migration of the shoreline inland.	The earth embankments are expected to fail during this period, with regular flooding.	The rate of erosion at the shoreline will accelerate as a result of sea level rise.	Complete failure of the embankments, with regular flooding.	The rate of erosion at the shoreline will accelerate.
Gloucester to north Sharpness						
Llanthony Weir to Rea (left bank, east channel of The Partings)	The earth embankments and flood walls will deteriorate and fail	Erosion will continue at the coast resulting in a migration of the	The earth embankments and flood walls are expected to fail	The rate of erosion at the shoreline will accelerate as a result of sea level	Complete failure of the embankments and flood walls, with constrained flooding.	The rate of erosion at the shoreline will accelerate.

Baseline Scenario 1 – No Active Intervention						
	Predicted Change for:					
Location	Years 0 – 20 (2025)		Years 20 – 50 (2055)		Years 50 – 100 (2105)	
	Defences	Natural Coast	Defences	Natural Coast	Defences	Natural Coast
	towards the end of this period. Breach of the defences will occur under the 10% AEP event: significant flood risk.	shoreline inland.	during this period, with constrained flooding.	rise.		
The Rea to Stonebench (left bank)	No defences: high ground.	Erosion will continue at the coast resulting in a migration of the shoreline inland.	No defences: high ground.	The rate of erosion at the shoreline will accelerate as a result of sea level rise.	No defences: high ground.	The rate of erosion at the shoreline will accelerate.
Stonebench to Windmill Hill (left bank)	The earth embankments will deteriorate and fail towards the end of this period. Breach will occur under the 100% AEP event: significant flood risk.	Erosion will continue at the coast resulting in a migration of the shoreline inland.	The earth embankments are expected to fail during this period, with regular flooding.	The rate of erosion at the shoreline will accelerate as a result of sea level rise.	Complete failure of the embankments, with regular flooding.	The rate of erosion at the shoreline will accelerate.
Windmill Hill to Waterend (left bank)	The earth embankments will remain in place during this period. Breach will occur under the 2% AEP event: medium	Erosion will continue at the coast resulting in a migration of the shoreline inland.	The earth embankments will deteriorate and fail during this period, with regular flooding.	The rate of erosion at the shoreline will accelerate as a result of sea level rise. MHWS would be located at the back of the	Complete failure of the embankments, with regular flooding.	The rate of erosion at the shoreline will accelerate. MHWS would be located at the back of the floodplain.

Baseline Scenario 1 – No Active Intervention						
	Predicted Change for:					
Location	Years 0 – 20 (2025)		Years 20 – 50 (2055)		Years 50 – 100 (2105)	
	Defences	Natural Coast	Defences	Natural Coast	Defences	Natural Coast
	flood risk.			floodplain.		
Waterend to Longney Crib (left bank)	The earth embankments will remain in place during this period. Breach will occur under the 0.5% AEP event: significant flood risk.	Erosion will continue at the coast resulting in a migration of the shoreline inland.	The earth embankments will deteriorate and fail during this period, with regular flooding.	The rate of erosion at the shoreline will accelerate as a result of sea level rise. MHWS would be located at the back of the floodplain.	Complete failure of the embankments, with regular flooding.	The rate of erosion at the shoreline will accelerate. MHWS would be located at the back of the floodplain.
Longney Crib to Cobbie's Rock (left bank)	The earth embankments and flood walls will remain in place during this period. Breach will occur under the 0.5% AEP event: limited flood risk.	Erosion will continue at the coast resulting in a migration of the shoreline inland.	The earth embankments and flood walls will deteriorate and fail during this period, with regular flooding.	The rate of erosion at the shoreline will accelerate as a result of sea level rise. MHWS would be located at the back of the floodplain.	Complete failure of the embankments and flood walls, with regular flooding.	The rate of erosion at the shoreline will accelerate. MHWS would be located at the back of the floodplain.
Cobbie's Rock to Priding (left bank)	The earth embankments and flood walls will remain in place during this period. Breach will occur under the 2% AEP event: medium flood risk.	Erosion will continue at the coast resulting in a migration of the shoreline inland.	The earth embankments and flood walls will deteriorate and fail during this period, with regular flooding.	The rate of erosion at the shoreline will accelerate as a result of sea level rise. MHWS would be located at the back of the floodplain.	Complete failure of the embankments and flood walls, with regular flooding.	The rate of erosion at the shoreline will accelerate. MHWS would be located at the back of the floodplain.

Baseline Scenario 1 – No Active Intervention						
	Predicted Change for:					
Location	Years 0 – 20 (2025)		Years 20 – 50 (2055)		Years 50 – 100 (2105)	
	Defences	Natural Coast	Defences	Natural Coast	Defences	Natural Coast
Priding to Hock Cliff (left bank)	The earth embankments will remain in place during this period. Breach will occur under the 0.5% AEP event: limited flood risk.	Erosion will continue at the coast resulting in a migration of the shoreline inland.	The earth embankments will deteriorate and fail during this period, with regular flooding.	The rate of erosion at the shoreline will accelerate as a result of sea level rise. MHWS would be located at the back of the floodplain.	Complete failure of the embankments, with regular flooding.	The rate of erosion at the shoreline will accelerate. MHWS would be located at the back of the floodplain.
Hock Cliff to Hock Ditch (left bank)	No defences: high ground.	Erosion will continue at the coast resulting in a migration of the shoreline inland.	No defences: high ground.	The rate of erosion at the shoreline will accelerate as a result of sea level rise.	No defences: high ground.	The rate of erosion at the shoreline will accelerate.
Hock Ditch to Splatt Bridge (left bank)	The canal banks will remain in place during this period. Breach will occur under the 0.1% AEP event: limited flood risk.	Erosion will continue at the coast resulting in a migration of the shoreline inland.	The canal banks will deteriorate and fail during this period, with regular flooding.	The rate of erosion at the shoreline will accelerate as a result of sea level rise. MHWS would be located at the back of the floodplain.	Complete failure of the canal banks, with regular flooding.	The rate of erosion at the shoreline will accelerate. MHWS would be located at the back of the floodplain.
Splatt Bridge to Royal Drift Outfall (left bank)	The groyne system will deteriorate and possibly fail in this period. Breach will occur under the 0.1% AEP event: limited flood risk.	Variable erosion and accretion of the shoreline will continue.	The earth embankments are expected to fail and allow regular flooding.	The rate of erosion at the shoreline will accelerate as a result of sea level rise. MHWS would be located at the back of the	Complete failure of the earth embankment, with regular flooding.	The rate of erosion at the shoreline will accelerate. MHWS would be located at the back of the floodplain.

Baseline Scenario 1 – No Active Intervention						
	Predicted Change for:					
Location	Years 0 – 20 (2025)		Years 20 – 50 (2055)		Years 50 – 100 (2105)	
	Defences	Natural Coast	Defences	Natural Coast	Defences	Natural Coast
				floodplain.		
Royal Drift Outfall to Tites Point (left bank)	No defences: high ground.	Historically stable cliffs will remain stable.	No defences: high ground.	Historically stable cliffs will remain stable.	No defences: high ground.	Historically stable cliffs will remain stable.
Sharpness to Severn Crossings						
Tites Point to Saniger Pill (left bank)	The canal bank, fronted by sunken barges, and earth embankment will remain in place for this period. Breach will occur under the 1% AEP event: limited flood risk.	Limited erosion of existing saltmarsh.	The canal bank and earth embankment will deteriorate and fail in this period, with regular but spatially constrained flooding.	The shoreline will migrate inland at an accelerated pace.	Complete failure of the canal bank and earth embankment, with regular but spatially constrained flooding.	Erosional processes will accelerate.
Saniger Pill to Berkeley Pill	The earth embankment will remain in place for this period. Breach will occur under the 1% AEP event: limited flood risk.	Limited erosion of existing saltmarsh.	The earth embankment will deteriorate and fail in this period, with regular but spatially constrained flooding.	The shoreline will migrate inland at an accelerated pace.	Complete failure of the earth embankment, with regular but spatially constrained flooding.	Erosional processes will accelerate.
Berkely Pill to Hill Pill	The earth embankment will remain in place for this period. Breach will occur under the 2% AEP event:	Limited erosion of existing saltmarsh.	The earth embankment will deteriorate and fail in this period, with regular flooding.	The shoreline will migrate inland at an accelerated pace. MHWS would be located at the back of the floodplain.	Complete failure of the earth embankment, with regular flooding.	Erosional processes will accelerate. MHWS would be located at the back of the floodplain.

Baseline Scenario 1 – No Active Intervention						
	Predicted Change for:					
Location	Years 0 – 20 (2025)		Years 20 – 50 (2055)		Years 50 – 100 (2105)	
	Defences	Natural Coast	Defences	Natural Coast	Defences	Natural Coast
	medium flood risk.					
Hill Pill to Oldbury Pill	The earth embankment will remain in place for this period. Breach will occur under the 5% AEP event: high flood risk.	Limited erosion of existing saltmarsh. MHWS would be located at the back of the floodplain.	The earth embankment will deteriorate and fail in this period, with regular flooding.	The shoreline will migrate inland at an accelerated pace. MHWS would be located at the back of the floodplain.	Complete failure of the earth embankment, with regular flooding.	Erosional processes will accelerate. MHWS would be located at the back of the floodplain.
Oldbury Pill to Littleton Pill	The earth embankment will remain in place for this period. Breach will occur under the 2% AEP event: medium flood risk.	Limited erosion of existing saltmarsh.	The earth embankment will deteriorate and fail in this period, with regular flooding.	The shoreline will migrate inland at an accelerated pace. MHWS would be located at the back of the floodplain.	Complete failure of the earth embankment, with regular flooding.	Erosional processes will accelerate. MHWS would be located at the back of the floodplain.
Littleton Pill to Aust Cliff	The earth embankment will remain in place for this period. Breach will occur under the 2% AEP event: medium flood risk.	Limited erosion of existing saltmarsh.	The earth embankment will deteriorate and fail in this period, with regular flooding. MHWS would be located at the back of the floodplain.	The shoreline will migrate inland at an accelerated pace. MHWS would be located at the back of the floodplain.	Complete failure of the earth embankment, with regular flooding. MHWS would be located at the back of the floodplain.	Erosional processes will accelerate. MHWS would be located at the back of the floodplain.
Severnside, Bristol and Avon						
Aust Cliff to Old Passage	No defences.	Hard geology cliff will remain stable, with the foreshore	No defences.	Hard geology cliff will remain stable, with the foreshore	No defences.	Hard geology cliff will remain stable, with the foreshore

Baseline Scenario 1 – No Active Intervention						
	Predicted Change for:					
Location	Years 0 – 20 (2025)		Years 20 – 50 (2055)		Years 50 – 100 (2105)	
	Defences	Natural Coast	Defences	Natural Coast	Defences	Natural Coast
		steepening.		steepening.		steepening.
Old Passage to New Passage	Embankments will remain in place. Breach will occur under the 0.5% AEP flood event: limited flood risk.	Low-lying saltmarsh-fronted shoreline will remain stable.	Embankments are expected to fail during this period, with regular extensive flooding.	Low-lying saltmarsh-fronted shoreline will remain stable. MHWS will be located at the back of the floodplain.	Complete failure of embankments, with regular extensive flooding.	Erosion of the wide saltmarsh towards the failed embankment. MHWS will be located at the back of the floodplain.
New Passage to Mitchell's Salt Rhine	The concrete revetment and railway embankment (although deteriorating) will remain in place in this period. Breach will occur under the 0.1% AEP flood event: limited flood risk.	The foreshore has historically experience minor erosion and accretion; therefore will remain stable.	The concrete revetment and railway embankment will further deteriorate and fail during this period, with regular extensive flooding.	The saltmarsh will undergo erosion. MHWS will be located at the back of the floodplain.	Complete failure of embankments and revetments, with regular extensive flooding.	The saltmarsh will undergo erosion. MHWS will be located at the back of the floodplain.
Mitchell's Salt Rhine to Avonmouth Pier	The earth embankment and concrete walls will deteriorate and fail during this period. Breach will occur under the 5% AEP flood event: significant flood	The foreshore has historically experience minor erosion and accretion; therefore will remain stable.	The earth embankment and concrete walls are expected to fail during this period, with constrained flooding.	The saltmarsh will undergo erosion.	Complete failure of earth embankment and concrete walls, with constrained flooding.	The saltmarsh will undergo erosion.

Baseline Scenario 1 – No Active Intervention						
	Predicted Change for:					
Location	Years 0 – 20 (2025)		Years 20 – 50 (2055)		Years 50 – 100 (2105)	
	Defences	Natural Coast	Defences	Natural Coast	Defences	Natural Coast
	risk.					
Avonmouth Pier to M5 motorway (right bank)	The earth embankment will deteriorate and fail in this period: the jetties will begin to deteriorate. Breach will occur under the 5% AEP flood event: significant flood risk.	The generally stable foreshore will continue.	The earth embankment will further deteriorate and fail during this period, with constrained flooding.	The generally stable foreshore will continue.	Complete failure of earth embankment, with constrained flooding.	The generally stable foreshore will continue.
M5 motorway to Cumberland Basin (right bank)	The earth embankment and concrete/masonry walls will deteriorate and possibly fail this period. Breach will occur under the 1% AEP flood event: significant flood risk.	Hard geology will remain stable.	The earth embankment and concrete/masonry walls are expected to fail in this period, with constrained flooding.	Hard geology will remain stable.	Complete failure of assets, with constrained flooding.	Hard geology will remain stable.
Cumberland Basin to Netham Weir (both banks)	The mixture of defences will deteriorate and possibly fail this period. Breach will occur under the 2% to 0.2% AEP flood	Hard geology will remain stable.	The mixture of defences are expected to fail in this period, with constrained flooding.	Hard geology will remain stable.	Complete failure of assets, with constrained flooding.	Hard geology will remain stable.

Baseline Scenario 1 – No Active Intervention						
	Predicted Change for:					
Location	Years 0 – 20 (2025)		Years 20 – 50 (2055)		Years 50 – 100 (2105)	
	Defences	Natural Coast	Defences	Natural Coast	Defences	Natural Coast
	event: limited to medium flood risk.					
Cumberland Basin to Pill (left bank)	The mixture of defences will deteriorate and possibly fail this period. Breach will occur under the 1% to 100% AEP flood event: limited to significant flood risk.	Hard geology will remain stable.	The mixture of defences are expected to fail in this period, with constrained flooding.	Hard geology will remain stable.	Complete failure of assets, with constrained flooding.	Hard geology will remain stable.
Pill to Portbury Pier (left bank)	The earth embankment will deteriorate and fail in this period. Breach will occur under the 0.1% AEP event: limited flood risk.	The generally stable foreshore will continue.	The failed earth embankment will allow constrained flooding due to high made ground levels.	The generally stable foreshore will continue.	The failed earth embankment will allow constrained flooding due to high made ground levels.	The generally stable foreshore will continue.
Portbury Pier to west of the Old Pier, Portishead	Earth embankment will remain in place for this period. Breach will occur under the 0.1% AEP flood event: limited flood risk.	Wide expanse of stable saltmarsh will continue.	The earth embankment are expected to fail in this period and allow widespread flooding.	Wide expanse of eroding saltmarsh will continue. MHWS will be located at the back of the floodplain, creating tidal islands.	The failed earth embankment will allow widespread flooding.	Wide expanse of eroding saltmarsh. MHWS will be located at the back of the floodplain, creating tidal islands.

Baseline Scenario 1 – No Active Intervention						
	Predicted Change for:					
Location	Years 0 – 20 (2025)		Years 20 – 50 (2055)		Years 50 – 100 (2105)	
	Defences	Natural Coast	Defences	Natural Coast	Defences	Natural Coast
Portishead and Clevedon						
Old Pier, Portishead to Portishead Point	No defences: high ground.	Resistant carboniferous limestone cliff coast.	No defences: high ground.	Resistant carboniferous limestone cliff coast.	No defences: high ground.	Resistant carboniferous limestone cliff coast.
Woodhill Bay	Masonry wall will possibly fail but due to promenade width would not affect flooding. Limited flood risk.	Historically stable saltmarsh will continue.	Continued erosion of the promenade would occur, although flood risk would still be limited.	Previously stable saltmarsh would begin to erode.	Complete erosion of promenade and sea level rise would result in widespread flooding.	Saltmarsh would continue to erode. MHWS will be located at the back of the floodplain.
Kilkenny Bay to Ladye Point	No defences: high ground.	Resistant carboniferous limestone cliff coast.	No defences: high ground.	Resistant carboniferous limestone cliff coast.	No defences: high ground.	Resistant carboniferous limestone cliff coast.
Clevedon	Masonry wall will deteriorate but remain in place. Breach will occur in the event of the 0.5% AEP flood: limited flood risk.	Rocky platform with cobbles would remain stable.	Continued deterioration of the masonry wall would result in failure and constrained flooding.	Rocky platform with cobbles would remain stable.	Failed masonry wall would allow constrained flooding.	Rocky platform with cobbles would remain stable.
Kingston Seymour to Sand Bay						
Wains Hill to St. Thomas Head (Kingston Seymour Bay)	Armoured coastal embankments will remain in place. Breach will occur in	Varying erosion and accretion, with a general retreat rate of 1 m/yr.	Armoured coastal embankments will deteriorate and fail in this period, with	Accelerated erosion of the saltmarsh will begin to undermine the coastal	Complete failure of all defences is expected in this period, with	Continued acceleration of erosion, with shoreline moving

Baseline Scenario 1 – No Active Intervention						
	Predicted Change for:					
Location	Years 0 – 20 (2025)		Years 20 – 50 (2055)		Years 50 – 100 (2105)	
	Defences	Natural Coast	Defences	Natural Coast	Defences	Natural Coast
	the event of the 10% AEP flood: significant flood risk. Fluvial embankments are expected to fail in this period, with widespread flooding.	MHWS will be located at the back of the floodplain, creating tidal islands.	widespread regular flooding.	embankments. MHWS will be located at the back of the floodplain, creating tidal islands.	widespread regular flooding.	significantly landward. MHWS will be located at the back of the floodplain, creating tidal islands.
St. Thomas Head to Sand Point	No defences.	Cliffed shoreline will remain stable, steepening of the foreshore expected.	No defences.	Cliffed shoreline will remain stable, steepening of the foreshore expected.	No defences.	Cliffed shoreline will remain stable, steepening of the foreshore expected.
Sand Bay	Sand dunes will remain in place. Breach will occur in the event of the 0.5% AEP flood.	Foreshore expected to have a steeper intertidal zone, resulting in the retreat of the MHW and MLW marks.	Sand dunes will erode and fail in this period, with regular extensive flooding.	Accelerated erosion through sand dunes. MHWS will be located at the back of the floodplain, creating tidal islands.	Complete failure of sand dunes, with regular extensive flooding.	Accelerated erosion past sand dunes. MHWS will be located at the back of the floodplain, creating tidal islands.
South Kewstroke to Birnbeck Island	No defences.	Hard geology with relatively stable shoreline.	No defences.	Hard geology with relatively stable shoreline.	No defences.	Hard geology with relatively stable shoreline.
The Holms						
Flat Holm	No defences.	Hard geology with relatively stable	No defences.	Hard geology with relatively stable	No defences.	Hard geology with relatively stable

Baseline Scenario 1 – No Active Intervention						
	Predicted Change for:					
Location	Years 0 – 20 (2025)		Years 20 – 50 (2055)		Years 50 – 100 (2105)	
	Defences	Natural Coast	Defences	Natural Coast	Defences	Natural Coast
		shoreline.		shoreline.		shoreline.
Steep Holm	No defences.	Hard geology with relatively stable shoreline.	No defences.	Hard geology with relatively stable shoreline.	No defences.	Hard geology with relatively stable shoreline.

Baseline Case 2 – With Present Management

Baseline Scenario 1 – With Present Management						
Predicted Scenario Under Present Management (SMP1 Set Policy):						
Locations	Existing		Short Term		Long Term	
	Present Management (SMP1 Policy) and Defences	Natural Coast	Present Management (SMP1 Policy) and Defences	Natural Coast	Present Management (SMP1 Policy) and Defences	Natural Coast
Penarth						
Lavernock Point to Penarth Esplanade	Do Nothing The concrete and masonry sea wall alongside Cliff Hill will remain in place. High ground prevents flood risk.	There has been little change in the cliff position over the past 100 years, and this is expected to continue. Flattening of the foreshore is expected.	Do Nothing The concrete and masonry wall is expected to remain in place, although its condition will deteriorate. High ground prevents flood risk.	Cliff erosion rates are expected to increase where not protected, due to sea level rise and greater storminess. The foreshore will continue to flatten and erode.	Do Nothing The concrete and masonry wall alongside Cliff Hill are expected to fail in this period. High ground prevents flood risk.	Cliff erosion rates will continue to increase, with the now unprotected section also eroding more rapidly. Erosion would be punctuated by significant cliff falls rather than continual erosion. The foreshore will continue to flatten and erode.
Penarth Esplanade: Cliff Road to The Kymin	Hold the Line Defences to hold the shoreline position with maintenance. Penarth Esplanade sea wall is expected to maintain the existing shoreline. SoP against breach of 5% AEP.	Defences to hold the shoreline position.	Hold the Line Increasing maintenance needed to maintain the integrity and effectiveness of the seawall.	Defences to hold the shoreline position. Foreshore narrowing of the shingle beach as result of increased MHWS and storminess.	Hold the Line Significant maintenance needed to maintain the integrity and effectiveness of the seawall.	Defences to hold the shoreline position. Further foreshore narrowing of the shingle beach.

Baseline Scenario 1 – With Present Management						
Predicted Scenario Under Present Management (SMP1 Set Policy):						
Locations	Existing		Short Term		Long Term	
	Present Management (SMP1 Policy) and Defences	Natural Coast	Present Management (SMP1 Policy) and Defences	Natural Coast	Present Management (SMP1 Policy) and Defences	Natural Coast
Penarth Head	Hold the Line 4 groynes on North face to hold the shoreline with significant maintenance.	Defences to hold the shoreline position. There will be narrowing of the shingle beach.	Hold the Line (or retreat the Line by cliff control) Significant improvements/replacement of groynes required to maintain the integrity and effectiveness of the seawall and hold the line.	Defences to hold the shoreline position. There will be further foreshore narrowing of the shingle beach.	Hold the Line (or retreat the Line by cliff control) The practice of maintaining the shoreline with the present groynes will become technically inefficient with rising sea levels and increased storminess proving the sediment capture ineffective. More significant management regimes would be needed to hold the line.	Defences to hold the shoreline position.
Cardiff Area						
Cardiff Bay Barrage	Hold the Line Cardiff Bay Barrage over 1km is expected to maintain the existing shoreline. SoP against breach of > 0.1% AEP.	Defences to hold the present shoreline.	Hold the Line The Cardiff Bay Barrage is expected to maintain the shoreline position. SoP against flooding of > 0.1%.	Defences to hold the present shoreline.	Hold the Line Cardiff Bay Barrage to hold the current shoreline with maintenance.	Defences to hold the present shoreline.
Cardiff Flats to Pengam Moor	Hold the Line Significant improvements/replacement of rock armouring required in order to maintain the	Significant improvements/replacement of rock armour required to prevent the	Hold the Line Significant improvements/replacement of rock armouring required in order to maintain the integrity,	Significant improvements/replacement of rock armour required to prevent the	Hold the Line Significant improvements/replacement of rock armouring required in order to maintain the integrity,	Significant improvements/replacement of rock armour required to prevent the

Baseline Scenario 1 – With Present Management						
Predicted Scenario Under Present Management (SMP1 Set Policy):						
Locations	Existing		Short Term		Long Term	
	Present Management (SMP1 Policy) and Defences	Natural Coast	Present Management (SMP1 Policy) and Defences	Natural Coast	Present Management (SMP1 Policy) and Defences	Natural Coast
	integrity, effectiveness of the defence, and to Hold the Line. Relatively high made ground levels limit flood risk.	natural historic erosion of the shoreline.	effectiveness of the defence, and to Hold the Line. Relatively high made ground levels limit flood risk.	natural historic erosion of the shoreline.	effectiveness of the defence, and to Hold the Line. Relatively high made ground levels limit flood risk.	natural historic erosion of the shoreline.
River Rhymney	Hold the Line Mixture of defences to hold the shoreline position. Additional maintenance and improvement of defences is required to maintain 0.5% AEP flood risk.	The mixture of defences, where adjacent to the river, will hold the banks in place.	Hold the Line Significant maintenance required to ensure position of the shoreline is held. Additional maintenance and improvement of defences is required to maintain 0.5% AEP flood risk.	The mixture of defences, where adjacent to the river, will hold the banks in place.	Hold the Line Replacement defences required to Hold the Line. It is technically possible to manage the shoreline as current policy sets but this will become unsustainable practice in the long term. More significant management regimes would be needed to hold the line.	The mixture of defences, where adjacent to the river, will hold the banks in place.
Wentlooge						
Rumney Great Wharf	Hold the Line Defences to hold the shoreline. Flood risk is limited.	The saltmarsh shoreline will retreat toward the defence line.	Hold the Line or Retreat the Line Defences will require some maintenance in order to hold the present shoreline.	The saltmarsh shoreline will retreat toward the defence line.	Hold the Line or Retreat the Line Significant maintenance/replacement of defences will be required to hold the present shoreline and prevent regular flooding. A retreated defence line will allow flood risk to areas further inland to	The saltmarsh shoreline will retreat toward the defence line.

Baseline Scenario 1 – With Present Management						
Predicted Scenario Under Present Management (SMP1 Set Policy):						
Locations	Existing		Short Term		Long Term	
	Present Management (SMP1 Policy) and Defences	Natural Coast	Present Management (SMP1 Policy) and Defences	Natural Coast	Present Management (SMP1 Policy) and Defences	Natural Coast
					be minimised.	
Peterstone Great Wharf	Hold the Line Defences to hold the shoreline, although flood risk remains significant.	The saltmarsh shoreline will retreat toward the defence line.	Hold the Line Defences will require some maintenance in order to hold the present shoreline. Flood risk increases.	The saltmarsh shoreline will retreat toward the defence line.	Hold the Line or Retreat the Line Significant maintenance/replacement of defences will be required to hold the present shoreline and prevent regular flooding. More significant management regimes would be needed to hold the line. A retreated defence line will allow flood risk to areas further inland to be minimised.	The saltmarsh shoreline will retreat toward the defence line.
Peterstone Gout to east of Outfall Lane	Hold the Line Defences to hold the shoreline. Flood risk is limited.	The saltmarsh shoreline will retreat toward the defence line.	Hold the Line Defences will require some maintenance in order to hold the present shoreline.	The saltmarsh shoreline will retreat toward the defence line.	Hold the Line or Retreat the Line Significant maintenance/replacement of defences will be required to hold the present shoreline and prevent regular flooding. More significant management regimes would be needed to hold the line. A retreated defence line will allow flood risk to areas further inland to be minimised.	The saltmarsh shoreline will retreat toward the defence line.

Baseline Scenario 1 – With Present Management						
Predicted Scenario Under Present Management (SMP1 Set Policy):						
Locations	Existing		Short Term		Long Term	
	Present Management (SMP1 Policy) and Defences	Natural Coast	Present Management (SMP1 Policy) and Defences	Natural Coast	Present Management (SMP1 Policy) and Defences	Natural Coast
					inland to be minimised.	
East of Outfall Lane to River Ebbw (west bank)	Hold the Line Defences to hold the shoreline. Flood risk is limited.	The saltmarsh shoreline will retreat toward the defence line.	Hold the Line Defences to hold the shoreline. Flood risk is limited.	The saltmarsh shoreline will retreat toward the defence line.	Hold the Line or Retreat the Line Significant maintenance/replacement of defences will be required to hold the present shoreline and prevent regular flooding. A retreated defence line will allow flood risk to areas further inland to be minimised.	The saltmarsh shoreline will retreat toward the defence line.
Newport Area and the River Usk						
Ebbw River to the Transporter Bridge (right bank)	Hold the Line Significant maintenance/replacement of defences is required to hold the present shoreline and reduce flood risk.	Defences to hold the shoreline.	Hold the Line Significant maintenance/replacement of defences is required to hold the present shoreline and reduce flood risk.	Defences to hold the shoreline.	Hold the Line Replacement of defences is required to hold the present shoreline. Current practice becomes ineffective.	Defences to hold the shoreline.
Transporter Bridge to the M4 (right bank)	Hold the Line Significant maintenance/replacement of defences is required to hold the present shoreline and reduce flood risk.	Defences to hold the shoreline.	Hold the Line Significant maintenance/replacement of defences is required to hold the present shoreline and reduce flood risk.	Defences to hold the shoreline.	Hold the Line or Retreat the Line Replacement of defences is required to hold the present shoreline. More significant management regimes would be needed to hold the line. Current practice	Defences to hold or realign the shoreline.

Baseline Scenario 1 – With Present Management						
Predicted Scenario Under Present Management (SMP1 Set Policy):						
Locations	Existing		Short Term		Long Term	
	Present Management (SMP1 Policy) and Defences	Natural Coast	Present Management (SMP1 Policy) and Defences	Natural Coast	Present Management (SMP1 Policy) and Defences	Natural Coast
					becomes ineffective.	
The M4 to Caerleon (both banks)	Hold the Line Significant maintenance/replace ment of defences is required to hold the present shoreline and reduce flood risk.	Defences to hold the shoreline.	Hold the Line Significant maintenance/replacement of defences is required to hold the present shoreline and reduce flood risk.	Defences to hold the shoreline.	Hold the Line or Retreat the Line Replacement of defences is required to hold the present shoreline. More significant management regimes would be needed to hold the line. Current practice becomes ineffective.	Defences to hold or realign the shoreline.
M4 to Spytty Pill (left bank)	Hold the Line Significant maintenance/replace ment of defences is required to hold the present shoreline and reduce flood risk.	Defences to hold the shoreline.	Hold the Line Significant maintenance/replacement of defences is required to hold the present shoreline and reduce flood risk.	Defences to hold the shoreline.	Hold the Line Replacement of defences is required to hold the present shoreline. More significant management regimes would be needed to hold the line. Current practice becomes ineffective.	Defences to hold the shoreline.
Spytty Pill to Uskmouth Power Station (left bank)	Hold the Line Significant maintenance/replace ment of defences is required to hold the present shoreline and reduce flood risk.	Defences to hold the shoreline.	Hold the Line Significant maintenance/replacement of defences is required to hold the present shoreline and reduce flood risk.	Defences to hold the shoreline.	Hold the Line Replacement of defences is required to hold the present shoreline. More significant management regimes would be needed to hold the line. Current practice	Defences to hold the shoreline.

Baseline Scenario 1 – With Present Management						
Predicted Scenario Under Present Management (SMP1 Set Policy):						
Locations	Existing		Short Term		Long Term	
	Present Management (SMP1 Policy) and Defences	Natural Coast	Present Management (SMP1 Policy) and Defences	Natural Coast	Present Management (SMP1 Policy) and Defences	Natural Coast
					becomes ineffective.	
Uskmouth Power Station (AES Fifoots Point PS) to Saltmarsh Farm	Hold the Line (Locally Retreat) The defences will remain in place for this period, holding the present shoreline.	Defences to hold the shoreline.	Hold the Line The defences will remain in place for this period, holding the present shoreline. Some maintenance required to maintain level of flood defence.	Defences to hold the shoreline.	Hold the Line of Retreat the Line Significant maintenance/replacement of defences is required to hold the present shoreline and maintain level of flood defence. More significant management regimes would be needed to hold the line.	Defences to hold the shoreline.
Saltmarsh Farm to Gold Cliff	Hold the Line Defences to hold the shoreline. Some maintenance required to groyne system to maintain current function.	Defences to hold the shoreline. Saltmarsh expected to retreat in line with historic rates.	Hold the Line (or Locally Retreat the Line) Significant maintenance to defences required to maintain current standard of protection and hold the present shoreline.	Defences to hold the shoreline. Accelerated retreat of saltmarsh as a result of sea level rise and increased storminess. Retreat of defences to match retreat of the natural shoreline will increase the effectiveness of sustainability of defences.	Hold the Line or Retreat the Line Significant maintenance/replacement of defences required to maintain current standard of protection and hold the present shoreline. More significant management regimes would be needed to hold the line.	Accelerated retreat of saltmarsh as a result of sea level rise and increased storminess. Retreat of defences to match retreat of the natural shoreline will increase the effectiveness of sustainability of defences.

Baseline Scenario 1 – With Present Management						
Predicted Scenario Under Present Management (SMP1 Set Policy):						
Locations	Existing		Short Term		Long Term	
	Present Management (SMP1 Policy) and Defences	Natural Coast	Present Management (SMP1 Policy) and Defences	Natural Coast	Present Management (SMP1 Policy) and Defences	Natural Coast
Caldicot Levels						
Gold Cliff to West Pill	Hold the Line Defences to hold the shoreline.	Defences to hold the shoreline. Saltmarsh expected to retreat in line with historic rates.	Hold the Line Maintenance to defences is required to maintain the current standard of protection and hold the shoreline.	Defences to hold the shoreline. Accelerated retreat of saltmarsh as a result of sea level rise and increased storminess.	Hold the Line or Retreat the Line Significant maintenance/ replacement of defences required to maintain current standard of protection and hold the present shoreline. More significant management regimes would be needed to hold the line.	Accelerated retreat of saltmarsh as a result of sea level rise and increased storminess. Retreat of defences to match retreat of the natural shoreline will increase the effectiveness of sustainability of defences.
West Pill to West of Sudbrook Point	Hold the Line Defences to hold the shoreline.	Defences to hold the shoreline. Saltmarsh expected to retreat in line with historic rates.	Hold the Line Maintenance to defences is required to maintain the current standard of protection and hold the shoreline.	Defences to hold the shoreline. Accelerated retreat of saltmarsh as a result of sea level rise and increased storminess.	Hold the Line or Retreat the Line Significant maintenance/ replacement of defences required to maintain current standard of protection and hold the present shoreline. More significant management regimes would be needed to hold the line.	Accelerated retreat of saltmarsh as a result of sea level rise and increased storminess. Retreat of defences to match retreat of the natural shoreline will increase the effectiveness of sustainability of defences.
Sudbrook Point to Black Rock	Do Nothing (Locally Hold the Line)	The Old Red Sandstone	Do Nothing (Locally Hold the Line or	The Old Red Sandstone	Do Nothing (Locally Hold the Line or	Shoreline retreat rates will increase

Baseline Scenario 1 – With Present Management						
Predicted Scenario Under Present Management (SMP1 Set Policy):						
Locations	Existing		Short Term		Long Term	
	Present Management (SMP1 Policy) and Defences	Natural Coast	Present Management (SMP1 Policy) and Defences	Natural Coast	Present Management (SMP1 Policy) and Defences	Natural Coast
	Defences to hold the shoreline.	headland at Sudbrook is predicted to remain stable or slowly erode.	Retreat the Line) Defences to hold the shoreline, some maintenance required to maintain standard of protection.	headland at Sudbrook is predicted to remain stable or slowly erode.	Retreat the Line) Significant maintenance/ replacement of defences required to maintain current standard of protection and hold the present shoreline.	due to accelerated climate change.
Black Rock to Thornwell	Hold the Line / Do Nothing The rock armoured and earth embankments are expected to remain in place. Breach will occur under the 0.5% AEP flood event: limited flood risk.	The foreshore is expected to flatten.	Hold the Line / Retreat the Line The rock armoured and earth embankments will remain in place with some maintenance. Breach will occur under the 5% AEP flood event: high flood risk.	Generally stable shoreline.	Hold the Line / Retreat the Line The rock armoured and earth embankments will remain in place with significant maintenance, although breach would occur under the 100% AEP flood event.	The shoreline will begin to retreat.
Beachley Point	Do Nothing No defences; high ground prevents flood risk.	Hard geology cliff will remain stable.	Do Nothing No defences; high ground prevents flood risk.	Hard geology cliff will remain stable.	Do Nothing No defences; high ground prevents flood risk.	Hard geology cliff will remain stable.
Chepstow, the River Wye and surrounding Area						
Thornwell to Alcove Wood (right bank)	Do Nothing (Locally Hold the Line) The flood defences at Chepstow will remain in place. Breach will occur under the 0.5% AEP flood event: limited flood risk.	Hard geology river will remain stable.	Do Nothing (Locally Hold the Line) The flood defences at Chepstow will deteriorate but remain in place in this period. Breach will occur under the 1% AEP flood event: limited flood	Hard geology river will remain stable.	Do Nothing (Locally Hold the Line) The flood defences are expected to fail in this period, allowing regular but spatially constrained flooding.	Hard geology river will remain stable.

Baseline Scenario 1 – With Present Management						
Predicted Scenario Under Present Management (SMP1 Set Policy):						
Locations	Existing		Short Term		Long Term	
	Present Management (SMP1 Policy) and Defences	Natural Coast	Present Management (SMP1 Policy) and Defences	Natural Coast	Present Management (SMP1 Policy) and Defences	Natural Coast
			risk.			
Alcove Wood-Chapel House Wood to Tintern Abbey (both banks)	Do Nothing (Locally Hold the Line) General high ground prevents flood risk except at Tintern.	Hard geology river will remain stable.	Do Nothing (Locally Hold the Line) General high ground prevents flood risk except at Tintern.	Hard geology river will remain stable.	Do Nothing (Locally Hold the Line) General high ground prevents flood risk except at Tintern.	Hard geology river will remain stable.
Chapel House Wood to Sedbury Sewage Works (left bank)	Do Nothing General high ground prevents flood risk.	Hard geology river will remain stable.	Do Nothing General high ground prevents flood risk.	Hard geology river will remain stable.	Do Nothing General high ground prevents flood risk.	Hard geology river will remain stable.
Sedbury Sewage Works to north Beachley (left bank)	Do Nothing Spatially constrained flooding.	Hard geology river will remain stable.	Do Nothing Spatially constrained flooding.	Hard geology river will remain stable.	Do Nothing Spatially constrained flooding.	Hard geology river will remain stable.
Chepstow to Lydney						
Beachley to Pillhouse Rocks	Do Nothing Predominantly high ground, with embankment at Sturch Pill deteriorating. Breach will occur under the 0.5% AEP event: limited flood risk.	Cliff will remain stable.	Do Nothing Predominantly high ground, with failed embankment at Sturch Pill. Regular flooding of constrained floodplain.	Cliff will remain stable.	Do Nothing or Retreat the Line Predominantly high ground, with embankment at Sturch Pill failing in this period. Regular flooding of constrained floodplain.	Cliff will remain stable.
Pillhouse Rocks to Guscar Rocks	Do Nothing Railway embankment with failed tide flaps, and intermittent high ground. Constrained flooding occurs during extreme	Variable erosion and accretion of the shoreline region will continue.	Do Nothing Railway embankment with failed tide flaps, and intermittent high ground. Constrained flooding occurs during extreme events.	Erosional processes will become dominant, with slow retreat of the shoreline (0.1m/year).	Do Nothing Railway embankment with failed tide flaps, and intermittent high ground. Constrained flooding occurs during extreme events.	Erosional processes will become dominant, with slow retreat of the shoreline (0.1m/year).

Baseline Scenario 1 – With Present Management						
Predicted Scenario Under Present Management (SMP1 Set Policy):						
Locations	Existing		Short Term		Long Term	
	Present Management (SMP1 Policy) and Defences	Natural Coast	Present Management (SMP1 Policy) and Defences	Natural Coast	Present Management (SMP1 Policy) and Defences	Natural Coast
	events.					
Lydney						
Guscar Rocks to/and Lydney Harbour	Hold the Line Defences to hold the present shoreline. Muddy foreshore margin to migrate landward.	Muddy foreshore margin to migrate landward. Variations across the shoreline.	Hold the Line Significant maintenance of the rock armoured embankment is required to maintain the existing standard of protection.	Erosional processes will become dominant, with retreat of the foreshore.	Hold the Line or Retreat the Line (locally) Significant maintenance/replacement of the rock armoured embankment is required to maintain the existing standard of protection. More significant management regimes would be needed to hold the line.	Dominant erosion processes will remove the muddy foreshore leaving increased pressure on defences - current defence practices may be ineffective at sustaining the current defence.
Lydney to Gloucester						
Lydney Harbour to Wellhouse Rock (right bank)	Hold the Line Defences to hold the line.	The mudstone cliffs will remain stable.	Hold the Line Defences to hold the line with some maintenance required to maintain the current standard of protection.	The mudstone cliff will undergo limited erosion.	Hold the Line Continued maintenance/replacement of defences required to maintain the present shoreline. More significant management regimes would be needed to hold the line.	The mudstone cliff will undergo limited erosion.
Wellhouse Rock to Poulton Court (right bank)	Hold the Line The railway retaining wall will hold the present shoreline.	The mudstone cliffs will remain stable.	Hold the Line Significant maintenance will be required to the railway retaining wall to maintain the current	The mudstone cliff will undergo limited erosion.	Hold the Line Significant maintenance will be required to the railway retaining wall to maintain the current	The mudstone cliff will undergo limited erosion.

Baseline Scenario 1 – With Present Management						
Predicted Scenario Under Present Management (SMP1 Set Policy):						
Locations	Existing		Short Term		Long Term	
	Present Management (SMP1 Policy) and Defences	Natural Coast	Present Management (SMP1 Policy) and Defences	Natural Coast	Present Management (SMP1 Policy) and Defences	Natural Coast
			shoreline position.		shoreline position. More significant management regimes would be needed to hold the line.	
Poulton Court to Whitescourt, Awre (right bank)	Do Nothing The earth embankment will deteriorate and fail in this period. Breach will occur under the 5% AEP event: high flood risk.	The mudstone cliffs will remain stable.	Do Nothing The failed earth embankment will allow regular but constrained flooding. MHWS would be located at the back of the floodplain.	The mudstone cliff will undergo limited erosion.	Do Nothing The failed earth embankment will allow regular but constrained flooding. MHWS would be located at the back of the floodplain.	The mudstone cliff will undergo limited erosion.
Whitescourt to Northington Farm (right bank)	Hold the Line Significant maintenance is required to the embankments and masonry protection to ensure the present defence line and standard of protection (high flood risk) is maintained.	Defences to hold the shoreline, with significant erosion of the foreshore.	Hold the Line or Retreat the Line Significant maintenance to / replacement of defences is required to hold the existing shoreline. Re-alignment of a retreated defence line would be a more sustainable approach to achieving the current standard of protection.	The rate of erosion at the shoreline will accelerate. MHWS would be located at the back of the floodplain.	Retreat the Line A retreated defence line will allow the current standard of defence to be achieved.	The rate of erosion at the shoreline will accelerate. MHWS would be located at the back of the floodplain.
Northington Farm to Newnham (right bank).	Do Nothing The earth embankments will deteriorate and fail towards the end of this period. Breach of the defences will	Erosion will continue at the coast resulting in a migration of the shoreline inland.	Do Nothing (generally) or Hold the Line (locally) The earth embankments are expected to fail during this period, with constrained flooding.	The rate of erosion at the shoreline will accelerate as a result of sea level rise.	Do Nothing (generally) or Hold the Line (locally) Complete failure of the embankments, with constrained flooding.	The rate of erosion at the shoreline will accelerate.

Baseline Scenario 1 – With Present Management						
Predicted Scenario Under Present Management (SMP1 Set Policy):						
Locations	Existing		Short Term		Long Term	
	Present Management (SMP1 Policy) and Defences	Natural Coast	Present Management (SMP1 Policy) and Defences	Natural Coast	Present Management (SMP1 Policy) and Defences	Natural Coast
	occur under the 5% AEP event, with constrained flooding.					
Newnham to Broadoak (right bank)	Hold the Line Significant maintenance required to the earth embankment and flood walls to maintain the current shoreline position and standard of protection. Breach of the defences will occur under the 5% AEP event.	Defences to hold the shoreline.	Hold the Line Significant maintenance to / replacement of the earth embankment is required to maintain the current shoreline position and standard of protection.	Defences to hold the shoreline. The rate of erosion at the shoreline will accelerate as a result of sea level rise.	Hold the Line Significant maintenance to / replacement of the earth embankment is required to maintain the current shoreline position and standard of protection. Present management practices become unsustainable the foreshore continues to erode at an accelerated rate.	Defences to hold the shoreline. The rate of erosion at the shoreline will accelerate.
Broadoak to Garden Cliff (right bank).	Hold the Line (locally Do Nothing) Significant maintenance required to the earth embankment and flood walls to maintain the current shoreline position and standard of protection locally. Breach of the defences will occur under the 5% AEP event.	Defences to hold the shoreline.	Hold the Line (locally Do Nothing) Significant maintenance required to the earth embankment and flood walls to maintain the current shoreline position and standard of protection locally. Regular flooding likely locally where NAI.	Defences to hold the shoreline. The rate of erosion at the shoreline will accelerate as a result of sea level rise.	Hold the Line (locally Do Nothing) Significant maintenance to / replacement of earth embankment is required and flood walls to maintain the current shoreline position and standard of protection locally. This action will be unsustainable although technically possible. Regular flooding likely locally where NAI.	Defences to hold the shoreline. The rate of erosion at the shoreline will accelerate.

Baseline Scenario 1 – With Present Management						
Predicted Scenario Under Present Management (SMP1 Set Policy):						
Locations	Existing		Short Term		Long Term	
	Present Management (SMP1 Policy) and Defences	Natural Coast	Present Management (SMP1 Policy) and Defences	Natural Coast	Present Management (SMP1 Policy) and Defences	Natural Coast
Garden Cliff to Rodley (right bank).	Hold the Line Significant maintenance is required to earth embankments to hold the present shoreline and standard of protection provided. Breach of the defences will occur under the 5% AEP event.	Defences to hold the shoreline.	Hold the Line Significant maintenance is required to earth embankments to hold the present shoreline and standard of protection provided.	Defences to hold the shoreline. The rate of erosion at the shoreline will accelerate as a result of sea level rise.	Hold the Line or Retreat the Line Significant maintenance to / replacement of defences would be required to earth embankments in the present position to hold shoreline and standard of protection. A retreated defence line would be a more sustainable approach to flood defence.	Defences to hold the shoreline. The rate of erosion at the shoreline will accelerate.
Rodley to Bollow (right bank)	Do Nothing No defences: high ground.	Erosion will continue at the coast resulting in a migration of the shoreline inland.	Do Nothing No defences: high ground.	The rate of erosion at the shoreline will accelerate as a result of sea level rise.	Do Nothing No defences: high ground.	The rate of erosion at the shoreline will accelerate.
Bollow to Wallmore Common (right bank)	Hold the Line Significant maintenance to earth embankments required to hold the present defence line and standard of protection. Breach of the defences will occur under the 1% AEP event.	Defences to hold the shoreline.	Hold the Line Significant maintenance to earth embankments required to hold the present defence line and standard of protection.	Defences to hold the shoreline. The rate of erosion at the shoreline will accelerate as a result of sea level rise.	Hold the Line or Retreat the Line Significant maintenance to/ replacement of earth embankments required to hold the present defence line and standard of protection. A retreated defence line would provide a more sustainable approach to maintaining the current	The rate of erosion at the shoreline will accelerate. MHWS would be located at the back of the floodplain.

Baseline Scenario 1 – With Present Management						
Predicted Scenario Under Present Management (SMP1 Set Policy):						
Locations	Existing		Short Term		Long Term	
	Present Management (SMP1 Policy) and Defences	Natural Coast	Present Management (SMP1 Policy) and Defences	Natural Coast	Present Management (SMP1 Policy) and Defences	Natural Coast
					standard of protection.	
Wallmore Common to Oakle Street (right bank)	Hold the Line Significant maintenance to earth embankments required to hold the present defence line and standard of protection. Breach of the defences will occur under the 5% AEP event.	Defences to hold the shoreline.	Hold the Line Significant maintenance to earth embankments required to hold the present defence line and standard of protection.	Defences to hold the shoreline. The rate of erosion at the shoreline will accelerate as a result of sea level rise.	Hold the Line Significant maintenance to/ replacement of earth embankments required to hold the present defence line and standard of protection.	Defences to hold the shoreline. The rate of erosion at the shoreline will accelerate.
Oakle Street to High Cross Farm (right bank)	Hold the Line Significant maintenance to earth embankments required to hold the present defence line and standard of protection. Breach of the defences will occur under the 10% AEP event.	Defences to hold the shoreline.	Hold the Line Significant maintenance to earth embankments required to hold the present defence line and standard of protection.	Defences to hold the shoreline. The rate of erosion at the shoreline will accelerate as a result of sea level rise.	Hold the Line Significant maintenance to/ replacement of earth embankments required to hold the present defence line and standard of protection.	Defences to hold the shoreline. The rate of erosion at the shoreline will accelerate.
High Cross Farm to Over Bridge (right bank)	Hold the Line Significant maintenance / replacement of the earth embankment required to hold the current shoreline and maintain the current	Defences to hold the shoreline.	Hold the Line or Retreat the Line Significant maintenance / replacement of the earth embankment required to hold the current shoreline and maintain the current standard of	The rate of erosion at the shoreline will accelerate as a result of sea level rise. MHWS would be located at	Hold the Line or Retreat the Line Significant maintenance/ replacement of the earth embankment required to hold the current shoreline and maintain the current standard of	The rate of erosion at the shoreline will accelerate. MHWS would be located at the back of the floodplain.

Baseline Scenario 1 – With Present Management						
Predicted Scenario Under Present Management (SMP1 Set Policy):						
Locations	Existing		Short Term		Long Term	
	Present Management (SMP1 Policy) and Defences	Natural Coast	Present Management (SMP1 Policy) and Defences	Natural Coast	Present Management (SMP1 Policy) and Defences	Natural Coast
	standard of protection: Breach of the defences will occur under the 10% AEP event: significant flood risk.		protection. The management practice of 'Hold the Line' becomes unsustainable as the erosion at the foreshore accelerates.	the back of the floodplain.	protection. The management practice of 'Hold the Line' becomes unsustainable as the erosion at the foreshore accelerates.	
Over Bridge to Maisemore Weir (right bank, west channel of The Partings)	Hold the Line Significant maintenance will be required to the earth embankments in order to hold the shoreline and maintain the current standard of protection: 10% AEP event: significant flood risk. The maintenance and possible replacement of the defences at the present position is technically possible but not sustainable as the foreshore continues to erode at an accelerating rate.	Defences to hold the shoreline.	Hold the Line Significant maintenance / replacement of the earth embankments will be required in order to hold the shoreline and maintain the current standard of protection. The maintenance and possible replacement of the defences at the present position is technically possible but not sustainable as the foreshore continues to erode at an accelerating rate.	Defences to hold the shoreline. The rate of erosion at the shoreline will accelerate as a result of sea level rise.	Hold the Line or Retreat the Line Significant maintenance / replacement of the earth embankments will be required in order to hold the shoreline and maintain the current standard of protection. The maintenance and possible replacement of the defences at the present position is technically possible but not sustainable as the foreshore continues to erode at an accelerating rate. Local retreat of the line will be a more sustainable approach to flood defence.	The rate of erosion at the shoreline will accelerate.
Gloucester and Tewkesbury						
Maisemore Weir to Ashleworth (right)	Severn CFMP Policy Reduce existing flood risk management	Erosion will continue at the	The earth embankments are expected to fail	The rate of erosion at the	Complete failure of the embankments, with	The rate of erosion at the

Baseline Scenario 1 – With Present Management						
Predicted Scenario Under Present Management (SMP1 Set Policy):						
Locations	Existing		Short Term		Long Term	
	Present Management (SMP1 Policy) and Defences	Natural Coast	Present Management (SMP1 Policy) and Defences	Natural Coast	Present Management (SMP1 Policy) and Defences	Natural Coast
bank)	<p>actions (accepting that flood risk will increase over Time)</p> <p>The earth embankments will deteriorate and fail towards the end of this period, with constrained flooding.</p>	coast resulting in a migration of the shoreline inland.	during this period, with constrained flooding.	shoreline will accelerate as a result of sea level rise.	constrained flooding.	shoreline will accelerate.
Ashleworth to Haw Bridge (right bank)	<p>Severn CFMP Policy Reduce existing flood risk management actions (accepting that flood risk will increase over Time)</p> <p>The earth embankments will deteriorate and fail towards the end of this period, with regular flooding.</p>	Erosion will continue at the coast resulting in a migration of the shoreline inland.	The earth embankments are expected to fail during this period, with regular flooding.	The rate of erosion at the shoreline will accelerate as a result of sea level rise.	Complete failure of the embankments, with regular flooding.	The rate of erosion at the shoreline will accelerate.
Alney Island (inner banks of The Partings)	<p>Severn CFMP Policy Reduce existing flood risk management actions (accepting that flood risk will increase over</p>	Erosion will continue at the coast resulting in a migration of the shoreline inland.	The flood walls are expected to fail during this period, with regular flooding.	The rate of erosion at the shoreline will accelerate as a result of sea	Complete failure of the flood walls, with regular flooding.	The rate of erosion at the shoreline will accelerate.

Baseline Scenario 1 – With Present Management						
Predicted Scenario Under Present Management (SMP1 Set Policy):						
Locations	Existing		Short Term		Long Term	
	Present Management (SMP1 Policy) and Defences	Natural Coast	Present Management (SMP1 Policy) and Defences	Natural Coast	Present Management (SMP1 Policy) and Defences	Natural Coast
	<p>Time)</p> <p>The flood walls, whilst deteriorating will remain in place. Flooding will occur under the 10% to 100% AEP event: significant flood risk.</p>			level rise.		
Haw Bridge to Ashleworth (left bank)	<p>Severn CFMP Policy Reduce existing flood risk management actions (accepting that flood risk will increase over time</p> <p>The earth embankments will deteriorate and fail towards the end of this period, with regular flooding.</p>	Erosion will continue at the coast resulting in a migration of the shoreline inland.	The earth embankments are expected to fail during this period, with regular flooding.	The rate of erosion at the shoreline will accelerate as a result of sea level rise.	Complete failure of the embankments, with regular flooding.	The rate of erosion at the shoreline will accelerate.
Ashleworth to Llanthony Weir (left bank)	<p>Severn CFMP Policy Reduce existing flood risk management actions (accepting that flood risk will increase over time</p>	Erosion will continue at the coast resulting in a migration of the shoreline inland.	The earth embankments are expected to fail during this period, with regular flooding.	The rate of erosion at the shoreline will accelerate as a result of sea level rise.	Complete failure of the embankments, with regular flooding.	The rate of erosion at the shoreline will accelerate.

Baseline Scenario 1 – With Present Management						
Predicted Scenario Under Present Management (SMP1 Set Policy):						
Locations	Existing		Short Term		Long Term	
	Present Management (SMP1 Policy) and Defences	Natural Coast	Present Management (SMP1 Policy) and Defences	Natural Coast	Present Management (SMP1 Policy) and Defences	Natural Coast
	The earth embankments will deteriorate and fail towards the end of this period, with regular flooding.					
Llanthony Weir to Rea (left bank, east channel of The Partings)	Hold the Line Significant maintenance will be required to the earth embankments and flood walls to hold the present shoreline and maintain the standard of protection. Breach of the defences will occur under the 10% AEP event: significant flood risk.	Defences to hold the shoreline.	Hold the Line Significant maintenance to / replacement of the earth embankments will be required to hold the present shoreline and maintain the current standard of protection.	Defences to hold the shoreline. The rate of erosion at the shoreline will accelerate as a result of sea level rise.	Hold the Line Significant maintenance to / replacement of the earth embankments will be required to hold the present shoreline and maintain the current standard of protection. The management practice becomes unsustainable as the rate of erosion at the shoreline accelerates.	Defences to hold the shoreline. The rate of erosion at the shoreline will accelerate.
Gloucester to north Sharpness						
Rea to Stonebench (left bank)	Hold the Line, locally Do Nothing No current defences: high ground. Defences may be required to hold the existing shoreline locally as erosion of the natural shoreline continues.	Defences to hold the shoreline. Erosion will continue at the coast resulting in a migration of the shoreline inland.	Hold the Line, locally Do Nothing No defences: high ground. Defences may be required to hold the existing shoreline locally as erosion of the natural shoreline accelerates.	Defences to hold the shoreline. The rate of erosion at the shoreline will accelerate as a result of sea level rise.	Hold the Line, locally Do Nothing No defences: high ground. Defences may be required to hold the existing shoreline locally as erosion of the natural shoreline accelerates.	Defences to hold the shoreline. The rate of erosion at the shoreline will accelerate.

Baseline Scenario 1 – With Present Management						
Predicted Scenario Under Present Management (SMP1 Set Policy):						
Locations	Existing		Short Term		Long Term	
	Present Management (SMP1 Policy) and Defences	Natural Coast	Present Management (SMP1 Policy) and Defences	Natural Coast	Present Management (SMP1 Policy) and Defences	Natural Coast
Stonebench to Windmill Hill (left bank)	Hold the Line, locally Do Nothing Significant maintenance to earth embankments is required in order to hold the existing shoreline and maintain the current standard of protection.	Defences to hold the shoreline. Erosion will continue at the coast resulting in a migration of the shoreline inland.	Hold the Line, locally Do Nothing Significant maintenance to earth embankments is required in order to hold the existing shoreline and maintain the current standard of protection preventing frequent flooding.	Defences to hold the shoreline. The rate of erosion at the shoreline will accelerate as a result of sea level rise.	Hold the Line, locally Do Nothing Significant maintenance to / replacement of the earth embankments will be required to hold the present shoreline and maintain the current standard of protection. The management practice becomes unsustainable as the rate of erosion at the shoreline accelerates.	Defences to hold the shoreline. The rate of erosion at the shoreline will accelerate.
Windmill Hill to Waterend (left bank)	Hold the Line Earth embankments to hold the existing shoreline. Standard of protection: breach will occur under the 2% AEP event: medium flood risk.	Defences to hold the shoreline.	Hold the Line Significant maintenance required to earth embankments to hold the existing shoreline and maintain the current standard of protection, preventing regular flooding.	Defences to hold the shoreline. The rate of erosion at the shoreline will accelerate as a result of sea level rise.	Hold the Line or Retreat the Line Significant maintenance to / replacement of the earth embankments will be required to hold the present shoreline and maintain the current standard of protection. The management practice may become unsustainable as the rate of erosion at the shoreline accelerates.	The rate of erosion at the shoreline will accelerate.
Waterend to Longney Crib (left bank)	Hold the Line The earth embankments will remain in place	Defences to hold the shoreline.	Hold the Line or Retreat the Line The earth embankments will deteriorate and fail	The rate of erosion at the shoreline will accelerate.	Retreat the Line The earth embankments will have failed in this period.	The rate of erosion at the shoreline will accelerate.

Baseline Scenario 1 – With Present Management						
Predicted Scenario Under Present Management (SMP1 Set Policy):						
Locations	Existing		Short Term		Long Term	
	Present Management (SMP1 Policy) and Defences	Natural Coast	Present Management (SMP1 Policy) and Defences	Natural Coast	Present Management (SMP1 Policy) and Defences	Natural Coast
	during this period. Breach will occur under the 0.5% AEP event: significant flood risk.		during this period, with regular flooding.			MHWS would be located at the back of the floodplain.
Longney Crib to Cobbie's Rock (left bank)	Hold the Line The earth embankments and flood walls will remain in place during this period to hold the present shoreline. Standard of protection: breach will occur under the 0.5% AEP event: limited flood risk.	Defences to hold the shoreline.	Hold the Line Significant maintenance to earth embankments to hold the shoreline and maintain the current standard of protection to prevent breach and regular flooding.	Defences to hold the shoreline. The rate of erosion at the shoreline will accelerate as a result of sea level rise.	Hold the Line or Retreat the Line Significant maintenance to / replacement of the embankments and flood walls will be required to hold the present shoreline and maintain the current standard of protection. The management practice (to Hold the Line) is technically possible although unsustainable in the long term as the erosion rate at the shoreline accelerates.	The rate of erosion at the shoreline will accelerate. MHWS would be located at the back of the floodplain.
Cobbie's Rock to Priding (left bank)	Hold the Line The earth embankments and flood walls will hold the present shoreline. Breach will occur under the 2% AEP event: medium flood risk.	Defences to hold the shoreline.	Hold the Line Significant maintenance to earth embankments and flood walls to hold the shoreline and maintain the current standard of protection to prevent breach and regular flooding.	Defences to hold the shoreline. The rate of erosion will accelerate as a result of sea level rise.	Hold the Line Significant maintenance to / replacement of the embankments and flood walls will be required to hold the present shoreline and maintain the current standard of protection. The management practice (to	Defences to hold the shoreline. The rate of erosion at the shoreline will accelerate.

Baseline Scenario 1 – With Present Management						
Predicted Scenario Under Present Management (SMP1 Set Policy):						
Locations	Existing		Short Term		Long Term	
	Present Management (SMP1 Policy) and Defences	Natural Coast	Present Management (SMP1 Policy) and Defences	Natural Coast	Present Management (SMP1 Policy) and Defences	Natural Coast
					Hold the Line) is technically possible although unsustainable in the long term as the erosion rate at the shoreline accelerates.	
Priding to Hock Cliff (left bank)	Hold the Line The earth embankments will hold the present shoreline. Breach will occur under the 0.5% AEP event: limited flood risk.	Defences to hold the shoreline.	Hold the Line Significant maintenance to earth embankments and flood walls to hold the shoreline and maintain the current standard of protection to prevent breach and regular flooding.	Defences to hold the shoreline. The rate of erosion at the shoreline will accelerate as a result of sea level rise.	Hold the Line Significant maintenance to / replacement of the embankments will be required to hold the present shoreline and maintain the current standard of protection. The management practice (to Hold the Line) is technically possible although unsustainable in the long term as the erosion rate at the shoreline accelerates. A retreat of the defence line would be a more sustainable approach to flood defence.	Defences to hold the shoreline. The rate of erosion at the shoreline will accelerate.
Hock Cliff to Hock Ditch (left bank)	Do Nothing No defences: high ground.	Erosion will continue at the coast resulting in a migration of the shoreline inland.	Do Nothing No defences: high ground.	The rate of erosion at the shoreline will accelerate as a result of sea level rise.	Do Nothing No defences: high ground.	The rate of erosion at the shoreline will accelerate.

Baseline Scenario 1 – With Present Management						
Predicted Scenario Under Present Management (SMP1 Set Policy):						
Locations	Existing		Short Term		Long Term	
	Present Management (SMP1 Policy) and Defences	Natural Coast	Present Management (SMP1 Policy) and Defences	Natural Coast	Present Management (SMP1 Policy) and Defences	Natural Coast
Hock Ditch to Splatt Bridge (left bank)	Hold the Line The canal banks will hold the shoreline. Breach will occur under the 0.1% AEP event: limited flood risk.	Defences to hold the shoreline.	Hold the Line Significant maintenance required to maintain the integrity of the canal banks, holding the present shoreline and maintaining the current standard of protection.	Defences to hold the shoreline. The rate of erosion at the shoreline will accelerate as a result of sea level rise.	Hold the Line or Retreat the Line Significant maintenance /replacement of defence required to maintain the integrity of the canal banks, holding the present shoreline and maintaining the current standard of protection. Continued maintenance of the shoreline becomes unsustainable as accelerated erosion rates increase the pressure on the defence.	The rate of erosion at the shoreline will accelerate. MHWS would be located at the back of the floodplain.
Splatt Bridge to Royal Drift Outfall (left bank)	Hold the Line Significant maintenance will be required to the current defence system in order to maintain the standard of defence and hold the shoreline.	Defences to hold the shoreline.	Hold the Line or Retreat the Line Replacement of the defence will be required in order to maintain the standard of defence and hold the shoreline. Replacement without retreat of the defence line may be unsustainable as continued erosion of the foreshore moves MHWS to the back of the floodplain.	The rate of erosion at the shoreline will accelerate as a result of sea level rise. MHWS would be located at the back of the floodplain.	Hold the Line or Retreat the Line Replacement of the defence will be required in order to maintain the standard of defence and hold the shoreline. Replacement without retreat of the defence line will be unsustainable as continued erosion of the foreshore moves MHWS to the back of the floodplain.	The rate of erosion at the shoreline will accelerate. MHWS would be located at the back of the floodplain.
Royal Drift Outfall	Hold the Line	Historically stable	Hold the Line	Historically	Hold the Line or	Historically stable

Baseline Scenario 1 – With Present Management						
Predicted Scenario Under Present Management (SMP1 Set Policy):						
Locations	Existing		Short Term		Long Term	
	Present Management (SMP1 Policy) and Defences	Natural Coast	Present Management (SMP1 Policy) and Defences	Natural Coast	Present Management (SMP1 Policy) and Defences	Natural Coast
to Tites Point (left bank)	No defences: high ground. Shoreline held.	cliffs will remain stable.	No defences: high ground. Shoreline held.	stable cliffs will remain stable.	Retreat the Line No defences: high ground. Shoreline held.	cliffs will remain stable.
Sharpness to Severn Crossings						
Tites Point to Saniger Pill (left bank)	Hold the Line (locally), Do Nothing (locally) The canal bank, fronted by sunken barges, and earth embankment will hold the present shoreline. Breach will occur under the 1% AEP event: limited flood risk.	Defences to hold the shoreline. Limited erosion of existing saltmarsh.	Hold the Line (locally), Do Nothing (locally) Significant maintenance required to the canal bank and earth embankment to hold the present shoreline and maintain the current standard of protection. Shoreline migration of the saltmarsh toward the defence line may make the maintenance of the existing shoreline unsustainable.	Defences to hold the shoreline. Significant erosion of existing saltmarsh.	Hold the Line (locally), Do Nothing (locally) Significant maintenance required to the canal bank and earth embankment to hold the present shoreline and maintain the current standard of protection. Accelerated shoreline migration of the saltmarsh toward the defence line may deem the maintenance of the existing shoreline, although technically possible, unsustainable.	Defences to hold the shoreline. Significant erosion of existing saltmarsh.
Saniger Pill to Berkeley Pill	Hold the Line The earth embankment defence will hold the present shoreline. Breach will occur under the 1% AEP event: limited flood risk.	Defences to hold the shoreline. Limited erosion of existing saltmarsh.	Hold the Line Significant maintenance required to the earth embankment to hold the present shoreline and current standard of protection.	Defences to hold the shoreline. Significant erosion of existing saltmarsh.	Retreat the Line Re-alignment of the shoreline in light of accelerated shoreline migration will render the maintenance of the existing standard of protection more sustainable.	Erosional processes will accelerate. MHWS would be located at the back of the floodplain.
Berkely Pill to Hill	Hold the Line	Defences to hold	Hold the Line	Defences to	Hold the Line or	Erosional

Baseline Scenario 1 – With Present Management						
Predicted Scenario Under Present Management (SMP1 Set Policy):						
Locations	Existing		Short Term		Long Term	
	Present Management (SMP1 Policy) and Defences	Natural Coast	Present Management (SMP1 Policy) and Defences	Natural Coast	Present Management (SMP1 Policy) and Defences	Natural Coast
Pill	The earth embankment will hold the present shoreline. Breach will occur under the 2% AEP event: medium flood risk.	the shoreline. Limited erosion of existing saltmarsh.	Significant maintenance required to the earth embankment to hold the present shoreline and current standard of protection.	hold the shoreline. Significant erosion of existing saltmarsh.	Retreat the Line Replacement of the earth embankment will be necessary to hold the present shoreline and achieve the current standard of protection. Re-alignment of a retreated defence in line with the eroding existing saltmarsh will be a more sustainable option.	processes will accelerate. MHWS would be located at the back of the floodplain.
Hill Pill to Oldbury Pill	Hold the Line The earth embankment will hold the present shoreline maintaining a standard of protection of the 5% AEP event breach: high flood risk.	Defences to hold the shoreline. Limited erosion of existing saltmarsh.	Hold the Line Significant maintenance is required to the earth embankment to hold the present shoreline and to maintain a standard of protection of the 5% AEP event breach: high flood risk.	Defences to hold the shoreline. Significant erosion of existing saltmarsh.	Hold the Line or Retreat the Line Significant maintenance to / replacement of the earth embankment will be necessary to hold the present shoreline and achieve the current standard of protection. Re-alignment of a retreated defence in line with the eroding existing saltmarsh will be a more sustainable option.	Erosional processes will accelerate. MHWS would be located at the back of the floodplain.
Oldbury Pill to Littleton Pill	Hold the Line The earth embankment will hold the existing shoreline and maintain a flood defence standard of	Defences to hold the shoreline. Limited erosion of existing saltmarsh.	Hold the Line Significant maintenance is required to the earth embankment to hold the present shoreline and to maintain the current	Defences to hold the shoreline. Significant erosion of existing	Hold the Line or Retreat the Line Significant maintenance / replacement of the earth embankment will be required to hold the	Erosional processes will accelerate. MHWS would be located at the back of the

Baseline Scenario 1 – With Present Management						
Predicted Scenario Under Present Management (SMP1 Set Policy):						
Locations	Existing		Short Term		Long Term	
	Present Management (SMP1 Policy) and Defences	Natural Coast	Present Management (SMP1 Policy) and Defences	Natural Coast	Present Management (SMP1 Policy) and Defences	Natural Coast
	2% AEP event breach: medium flood risk.		standard of protection.	saltmarsh.	present shoreline and achieve the present standard of protection.	floodplain.
Littleton Pill to Aust Cliff	Hold the Line The earth embankment will hold the existing shoreline and maintain a flood defence standard of 2% AEP event breach: medium flood risk.	Defences to hold the shoreline. Limited erosion of existing saltmarsh.	Hold the Line Significant maintenance is required to the earth embankment to hold the present shoreline and to maintain the current standard of protection.	Defences to hold the shoreline. Significant erosion of existing saltmarsh.	Hold the Line or Retreat the Line Significant maintenance / replacement of the earth embankment will be required to hold the present shoreline and achieve the present standard of protection.	Erosional processes will accelerate. MHWS would be located at the back of the floodplain.
Severnside, Bristol and Avon						
Aust Cliff to Old Passage	Do Nothing, locally Hold the Line No defences.	Hard geology cliff will remain stable, with the foreshore steepening.	Do Nothing, locally Hold the Line No defences.	Hard geology cliff will remain stable, with the foreshore steepening.	Do Nothing, locally Hold the Line No defences.	Hard geology cliff will remain stable, with the foreshore steepening.
Old Passage to New Passage	Hold the Line Defences to hold the current shoreline position.	Low-lying saltmarsh-fronted shoreline will remain stable.	Hold the Line Significant maintenance to defence works required to maintain current shoreline position and standard of protection.	Low-lying saltmarsh-fronted shoreline will remain stable.	Hold the Line or Retreat the Line Significant maintenance to / replacement of defence works required to maintain current standard of protection.	Erosion of the wide saltmarsh towards the embankment. MHWS will be located at the back of the floodplain.
New Passage to Mitchell's Salt Rhine	Hold the Line Defences to hold the current shoreline position. Maintenance required to maintain	The foreshore has historically experience minor erosion and accretion;	Hold the Line Significant maintenance to defence works required to maintain current shoreline position	Defences to hold the shoreline. The saltmarsh will undergo	Hold the Line or Retreat the Line Significant maintenance to defence works required to maintain	The saltmarsh will undergo erosion. MHWS will be located at the back of the

Baseline Scenario 1 – With Present Management						
Predicted Scenario Under Present Management (SMP1 Set Policy):						
Locations	Existing		Short Term		Long Term	
	Present Management (SMP1 Policy) and Defences	Natural Coast	Present Management (SMP1 Policy) and Defences	Natural Coast	Present Management (SMP1 Policy) and Defences	Natural Coast
	the current standard of protection.	therefore will remain stable.	and standard of protection.	erosion.	current shoreline position and standard of protection.	floodplain.
Mitchell's Salt Rhine to Avonmouth Pier	Hold the Line Significant maintenance to defence works required to maintain current shoreline position and standard of protection.	The foreshore has historically experience minor erosion and accretion; therefore will remain stable.	Hold the Line Significant maintenance to / replacement of defence works required to maintain current shoreline position and standard of protection.	Defences to hold the shoreline. The saltmarsh will undergo erosion.	Hold the Line or Retreat the Line Significant maintenance to / replacement of defence works required to maintain current shoreline position and standard of protection. Upkeep of the present defence may become ineffective against coastal processes.	The saltmarsh will undergo erosion. MHWS will be located at the back of the floodplain.
Avonmouth Pier to M5 motorway (right bank)	Hold the Line Significant maintenance to / replacement of defence works required to maintain current shoreline position and standard of protection.	The generally stable foreshore will continue.	Hold the Line Significant maintenance to / replacement of defence works required to maintain current shoreline position and standard of protection.	The generally stable foreshore will continue.	Hold the Line Significant maintenance to / replacement of defence works required to maintain current shoreline position and standard of protection.	The generally stable foreshore will continue.
M5 motorway to Cumberland Basin (right bank)	Hold the Line Maintenance to earth embankment and concrete/masonry walls required to hold the present shoreline and maintain the	Hard geology will remain stable.	Hold the Line Significant maintenance to / replacement of the earth embankment and concrete/masonry required to maintain current shoreline position	Hard geology will remain stable.	Hold the Line Significant maintenance to / replacement of the earth embankment and concrete/masonry required to maintain current shoreline	Hard geology will remain stable.

Baseline Scenario 1 – With Present Management						
Predicted Scenario Under Present Management (SMP1 Set Policy):						
Locations	Existing		Short Term		Long Term	
	Present Management (SMP1 Policy) and Defences	Natural Coast	Present Management (SMP1 Policy) and Defences	Natural Coast	Present Management (SMP1 Policy) and Defences	Natural Coast
	current standard of protection.		and standard of protection.		position and standard of protection.	
Cumberland Basin to Netham Weir (both banks)	Hold the Line Significant maintenance to / replacement of the mixture of defences required to maintain the current shoreline position standard of protection. Breach will occur under the 2% to 0.2% AEP flood event: limited to medium flood risk.	Hard geology will remain stable.	Hold the Line Significant maintenance to / replacement of the mixture of defences required to maintain the current shoreline position standard of protection.	Hard geology will remain stable.	Hold the Line Maintenance to the defences may be ineffective at maintaining the current shoreline and standard of protection. Improved defences required to hold the present shoreline and provide a standard of protective to match the current.	Hard geology will remain stable.
Cumberland Basin to Pill (left bank)	Do Nothing The mixture of defences will deteriorate and possibly fail this period. Breach will occur under the 1% to 100% AEP flood event: limited to significant flood risk.	Hard geology will remain stable.	Do Nothing The mixture of defences are expected to fail in this period, with constrained flooding.	Hard geology will remain stable.	Do Nothing Complete failure of assets, with constrained flooding.	Hard geology will remain stable.
Pill to Portbury Pier (left bank)	Hold the Line Significant maintenance to the earth embankment required to hold the present shoreline and	The generally stable foreshore will continue.	Hold the Line Significant maintenance to / replacement of the earth embankment required to hold the present shoreline and	The generally stable foreshore will continue.	Hold the Line Significant maintenance to / replacement of the earth embankment required to hold the present shoreline and	The generally stable foreshore will continue.

Baseline Scenario 1 – With Present Management						
Predicted Scenario Under Present Management (SMP1 Set Policy):						
Locations	Existing		Short Term		Long Term	
	Present Management (SMP1 Policy) and Defences	Natural Coast	Present Management (SMP1 Policy) and Defences	Natural Coast	Present Management (SMP1 Policy) and Defences	Natural Coast
	maintain the current standard of protection. Breach will occur under the 0.1% AEP event: limited flood risk.		maintain the current standard of protection against constrained flooding and subsequent erosion.		maintain the current standard of protection against constrained flooding and subsequent erosion.	
Portbury Pier to west of the Old Pier, Portishead	Hold the Line (locally Retreat the Line) Earth embankment defences will hold the present shoreline and maintain the current standard of protection of 0.1% AEP flood event: limited flood risk.	Wide expanse of stable saltmarsh will continue.	Hold the Line (locally Retreat the Line) Significant maintenance required to maintain the current shoreline position and maintain the current standard of protection to prevent widespread flooding.	Wide expanse of eroding saltmarsh will continue.	Hold the Line (locally Retreat the Line) Significant maintenance to / replacement of the earth embankment is required to maintain the current shoreline position and maintain the current standard of protection to prevent widespread flooding.	Wide expanse of eroding saltmarsh.
Portishead and Clevedon						
Old Pier, Portishead to Portishead Point	Do Nothing No defences: high ground.	Resistant carboniferous limestone cliff coast.	Do Nothing No defences: high ground.	Resistant carboniferous limestone cliff coast.	Do Nothing, locally Retreat the Line No defences: high ground.	Resistant carboniferous limestone cliff coast.
Woodhill Bay	Hold the Line Promenade to hold the existing shoreline.	Historically stable saltmarsh will continue.	Hold the Line Promenade to hold the existing shoreline, maintenance required to hold the existing level of defence.	Previously stable saltmarsh would begin to erode.	Hold the Line Significant maintenance / replacement of defence required to maintain current standard of protection.	Saltmarsh would continue to erode.
Kilkenny Bay to Ladye Point	Do Nothing No defences: high ground.	Resistant carboniferous limestone cliff	Do Nothing, locally Retreat the Line No defences: high	Resistant carboniferous limestone cliff	Do Nothing, locally Retreat the Line No defences: high	Resistant carboniferous limestone cliff

Baseline Scenario 1 – With Present Management						
Predicted Scenario Under Present Management (SMP1 Set Policy):						
Locations	Existing		Short Term		Long Term	
	Present Management (SMP1 Policy) and Defences	Natural Coast	Present Management (SMP1 Policy) and Defences	Natural Coast	Present Management (SMP1 Policy) and Defences	Natural Coast
		coast.	ground.	coast.	ground.	coast.
Clevedon	Hold the Line, locally Do Nothing Masonry wall will deteriorate but remain in place. Breach will occur in the event of the 0.5% AEP flood: limited flood risk.	Rocky platform with cobbles would remain stable.	Hold the Line, locally Retreat the Line or Do Nothing Continued deterioration of the masonry wall would result in failure and constrained flooding.	Rocky platform with cobbles would remain stable.	Hold the Line, locally Do Nothing Failed masonry wall would allow constrained flooding.	Rocky platform with cobbles would remain stable.
Kingston Seymour to Sand Bay						
Wains Hill to St Thomas Head	Hold the Line Defences to hold the current shoreline, maintenance required to maintain the current standard of protection.	Varying erosion and accretion, with a general retreat rate of 1 m/yr.	Hold the Line Significant maintenance/replacement of the defences required to ensure defences hold the shoreline and maintain the current standard of protection.	Accelerated erosion of the saltmarsh.	Hold the Line or Retreat the Line Replacement of the current defences will be required to hold the present shoreline.	Continued acceleration of erosion, with shoreline moving significantly landward. MHWS will be located at the back of the floodplain, creating tidal islands.
St. Thomas Head to Sand Point	Do Nothing No defences.	Cliffed shoreline will remain stable, steepening of the foreshore expected.	Do Nothing No defences.	Cliffed shoreline will remain stable, steepening of the foreshore expected.	Do Nothing No defences.	Cliffed shoreline will remain stable, steepening of the foreshore expected.
Sand Bay	Do Nothing Sand dunes will remain in place.	Foreshore expected to have a steeper	Do Nothing Significant erosion of the sand dunes will occur,	Accelerated erosion of the sand dunes.	Do Nothing Complete failure of sand dunes, with regular	Accelerated erosion past sand dunes. MHWS will

Baseline Scenario 1 – With Present Management						
Predicted Scenario Under Present Management (SMP1 Set Policy):						
Locations	Existing		Short Term		Long Term	
	Present Management (SMP1 Policy) and Defences	Natural Coast	Present Management (SMP1 Policy) and Defences	Natural Coast	Present Management (SMP1 Policy) and Defences	Natural Coast
	Breach will occur in the event of the 0.5% AEP flood.	intertidal zone, resulting in the retreat of the MHW and MLW marks.	with regular flooding possible.	MHWS will be located at the back of the floodplain, creating tidal islands.	extensive flooding.	be located at the back of the floodplain, creating tidal islands.
South Kewstoke to Binbeck Island	Do Nothing (locally Hold the Line) No defences.	Hard geology with relatively stable shoreline.	Do Nothing (locally Hold the Line) No defences.	Hard geology with relatively stable shoreline.	Do Nothing No defences.	Hard geology with relatively stable shoreline.
The Holms						
Flat Holm	Do Nothing No defences.	Hard geology with relatively stable shoreline.	Do Nothing No defences.	Hard geology with relatively stable shoreline.	Do Nothing No defences.	Hard geology with relatively stable shoreline.
Steep Holm	Do Nothing No defences.	Hard geology with relatively stable shoreline.	Do Nothing No defences.	Hard geology with relatively stable shoreline.	Do Nothing No defences.	Hard geology with relatively stable shoreline.

Annex A SMP1 Policies

SMP1 Process Unit	SMP1 MU	SMP1 MU name	Existing	short term	long term
Penarth	1/1	Lavernock Point to Cliff Road	Do nothing	Do nothing	Do nothing
	1/2	Cliff Road to The Kymin	Hold the Line	Hold the Line	Hold the Line
	1/3	Penarth Head	Hold the Line	Hold the Line / Retreat the Line	Hold the Line / Retreat the Line
Cardiff	2/1	Cardiff Bay	Hold the Line	Hold the Line	Hold the Line
Wentlooge	3/1	Cardiff Flats	Hold the Line	Hold the Line	Hold the Line
	3/2	N of Cardiff Flats to Pengham Green	Hold the Line	Hold the Line	Hold the Line
	3/3	River Rhymney	Hold the Line	Hold the Line	Hold the Line
	3/4	Rumney Great Wharf	Hold the line	Hold the Line / Retreat the Line	Hold the Line / Retreat the Line
	3/5	Peterstone Great Wharf	Hold the line	Hold the line	Hold the Line / Retreat the Line
	3/6	Peterstone Gout to east of Outfall Lane	Hold the line	Hold the line	Hold the Line / Retreat the Line
	3/7	East of Outfall Lane to New Gout	Hold the line	Hold the line	Hold the Line / Retreat the Line
	3/8	River Ebbw (west bank)	Hold the line	Hold the Line / Retreat the Line	Hold the Line / Retreat the Line
River Usk	4/1	River Ebbw (east bank) to transporter bridge	Hold the Line	Hold the Line	Hold the Line

	4/2	Transporter bridge to M4 (right bank)	Hold the Line	Hold the Line	Hold the Line / Retreat the Line
	4/3	M4 to Caerleon (both banks)	Hold the Line	Hold the Line	Hold the Line / Retreat the Line
	4/4	M4 to Spytty Pill (left bank)	Hold the Line	Hold the Line	Hold the Line
	4/5	Spytty Pill to Uskmouth power station (left bank)	Hold the Line	Hold the Line	Hold the Line
Uskmouth	5/1	Uskmouth power stn to Saltmarsh Farm	Hold the Line (locally retreat)	Hold the Line	Hold the Line / Retreat the Line
	5/2	Saltmarsh Farm to Gold Cliff	Hold the Line	Hold the Line (or locally retreat)	Hold the Line / Retreat the Line
Caldicot Levels	6/1	Gold Cliff to Cold Harbour Pill	Hold the Line	Hold the Line	Hold the Line / Retreat the Line
	6/2	Cold Harbour Pill to West Pill	Hold the Line	Hold the Line	Hold the Line / Retreat the Line
	6/3	West Pill to West of Sudbrook Point	Hold the Line	Hold the Line	Hold the Line / Retreat the Line
Severn Crossings	7/1	Sudbrook Point to Black Rock	Do nothing (locally hold)	Do nothing (locally hold or retreat)	Do nothing (locally hold or retreat)
	7/2	Black Rock to Thornwell	Hold the Line / Do nothing	Hold the Line / Retreat the Line	Hold the Line / Retreat the Line
	7/3	Beachley Point	Do nothing	Do nothing	Do nothing
	7/4	Aust Cliff to Old Passage	Do nothing (locally hold)	Do nothing (locally hold)	Do nothing (locally hold)
	7/5	Old Passage to New Passage	Hold the Line	Hold the Line	Hold the Line / Retreat the Line
River Wye	8/1	Chepstow - Thornwell to Alcove Wood (right bank)	Do nothing (locally hold)	Do nothing (locally hold)	Do nothing (locally hold)

	8/2	Alcove Wood to Tintern Abbey to Chapel House Wood	Do nothing (locally hold)	Do nothing (locally hold)	Do nothing (locally hold)
	8/3	Chapel House Wood to Sedbury Sewage Works (left bank)	Do nothing	Do nothing	Do nothing
	8/4	Sedbury sewage works to north Beachley (left bank)	Do nothing	Do nothing	Do nothing
Beachley to Sharpness	9/1	Beachley to Sedbury Cliffs (right bank)	Do nothing	Do nothing	Do nothing / Retreat the Line
	9/2	Sedbury Cliffs (right bank)	Do nothing	Do nothing	Do nothing
	9/3	Sturch Pill to Guscar Rocks (right bank)	Do nothing / Hold / Retreat	Do nothing / Hold / Retreat	Do nothing / Hold / Retreat
	9/4	Guscar Rocks to Lydney Mouth (right bank)	Hold the Line	Hold the Line	Hold the Line / Retreat the Line
	9/5	South of Sharpness to Berkeley Pill (left bank)	Hold the Line	Hold the Line	Retreat the Line
	9/6	Berkeley Power Station (left bank)	Hold the Line	Hold the Line	Hold the Line / Retreat the Line
	9/7	South of Berkeley Power Stn to Chapel House (left bank)	Hold the Line	Hold the Line	Hold the Line / Retreat the Line
	9/8	Chapel House to south of Oldbury Power Stn (left bank)	Hold the Line	Hold the Line	Hold the Line / Retreat the Line
	9/9	Oldbury to Littleton (left bank)	Hold the Line	Hold the Line	Hold the Line / Retreat the Line
Sharpness to Purton	10/1	Lydney Harbour to Cliff Farm (right bank)	Do nothing	Do nothing	Do nothing
	10/2	Cliff Farm to Wellhouse Rock (right bank)	Hold the Line	Hold the Line	Hold the Line

	10/3	Wellhouse Rock to Poulton Court (right bank)	Hold the Line	Hold the Line	Hold the Line
	10/4	Tites Point to South of Ridge Sand (left bank)	Hold the Line	Hold the Line	Hold the Line
	10/5	Sharpness (north) (left bank)	Hold the Line	Hold the Line	Hold the Line
	10/6	Sharpness (west) (left bank)	Hold (locally) / Do nothing (locally)	Hold (locally) / Do nothing (locally)	Hold (locally) / Do nothing (locally)
Tites Point to Hock Cliff	11/1	Poulton Court to Whitescourt, Awre (right bank)	Do nothing	Do nothing	Do nothing
	11/2	Whitescourt to Hayward (right bank)	Hold the Line	Hold the Line / Retreat the Line	Retreat the Line
	11/3	Hock Ditch to Frampton Breakwater (left bank)	Hold the Line	Hold the Line	Hold the Line / Retreat the Line
	11/4	Frampton Breakwater to the Dumbles (left bank)	Hold the Line	Hold the Line / Retreat the Line	Hold the Line / Retreat the Line
	11/5	The Royal Drift (left bank)	Hold the Line	Hold the Line	Hold the Line / Retreat the Line
Hock Cliff to Longley Pool	12/1	Hayward to Northington Farm (right bank)	Hold the Line	Hold the Line	
	12/2	Northington Farm to Portlands Nab (right bank)	Do nothing	Do nothing (hold locally)	Do nothing (hold locally)
	12/3	Portlands Nab to Newnham (right bank)	Do nothing	Do nothing (hold / retreat locally)	Do nothing (hold / retreat locally)
	12/4	Newnham to Broadoak (right bank)	Hold the Line	Hold the Line	Hold the Line
	12/5	Braodoak to Garden Cliff (right bank)	Hold the Line (do nothing locally)	Hold the Line (do nothing locally)	Hold the Line (do nothing locally)
	12/6	The Dumballs (right bank)	Hold the Line	Hold the Line	Hold the Line / Retreat the Line

	12/7	Longney Crib to Priding Wick Court (left bank)	Hold the Line	Hold the Line	Hold the Line
	12/8	Priding Wick Court to Longmarsh Pill (left bank)	Hold the Line	Hold the Line	Hold the Line / Retreat the Line
	12/9	Longmarsh Pill to Hock Ditch (left bank)	Do nothing	Do nothing	Do nothing
Longney Pool to Maisemore	13/1	Rodley to Bollow (right bank)	Do nothing	Do nothing	Do nothing
	13/2	Bollow to Hartland's Hill (right bank)	Hold the Line	Hold the Line	Hold the Line / Retreat the Line
	13/3	Hartland's Hill to Denny's Hill (right bank)	Hold the Line	Hold the Line	Hold the Line
	13/4	Denny Hill to Minsterworth (right bank)	Hold the Line	Hold the Line	Hold the Line
	13/5	Minsterworth Ham (right bank)	Hold the Line	Hold the Line	Hold the Line / Retreat the Line
The Weirs to Haw Bridge	14		fluvial	fluvial	fluvial
Avonmouth	15/1	New Passage to Severside Works	Hold the Line	Hold the Line	Hold the Line (retreat locally)
	15/2	Severside Works to Mitchell's Salt Rhine	Hold the Line	Hold the Line	Hold the Line / Retreat the Line
	15/3	Mitchell's salt Rhine to Avonmouth Pier	Hold the Line	Hold the Line	Hold the Line / Retreat the Line
	15/4	Portbury Pier to Old Pier, Portishead	Hold the Line	Hold the Line (retreat locally)	Hold the Line (retreat locally)
River Avon	16/1	Avonmouth Pier to Netham Weir (right bank)	Hold the Line	Hold the Line	Hold the Line
	16/2	Netham Weir to Burgh Walls	Hold the Line	Hold the Line	Hold the Line

		(left bank)			
	16/3	Chapel Pill (left bank)	Do nothing	Do nothing	Do nothing
	16/4	Chapel Pill to Portbury Pier (left bank)	Hold the Line	Hold the Line	Hold the Line
Clevedon	17/1	Old Pier to Portishead Point	Do nothing	Do nothing	Do nothing (retreat locally)
	17/2	Woodhill Bay	Hold the Line	Hold the Line	Hold the Line
	17/3	Kilkenny Bay to Redcliff Bay	Do nothing	Do nothing (retreat locally)	Do nothing (retreat locally)
	17/4	Redcliffe Bay to Ladye Point	Do nothing	Do nothing	Do nothing
	17/5	Clevedon	Hold the Line (do nothing locally)	Hold the line (retreat / do nothing locally)	Hold the line (retreat / do nothing locally)
Kingston Seymour	18/1	Wains Hill to Thomas Head	Hold the Line	Hold the Line	Hold the Line / Retreat the Line
Middle Hope	19/1	St Thomas Head to Sand Point	Do nothing	Do nothing	Do nothing
Sand Bay	20/1	Sand Point to Middle Hope car park	Do nothing	Do nothing	Do nothing
	20/2	Middle Hope car park to south Kewstoke	Hold the Line	Hold the Line	Hold the Line / Retreat the Line
	20/3	South Kewstoke to Birnbeck Island	Do nothing (locally hold)	Do nothing (locally hold)	Do nothing (locally hold / do nothing)

Annex B No Active Intervention Mapping



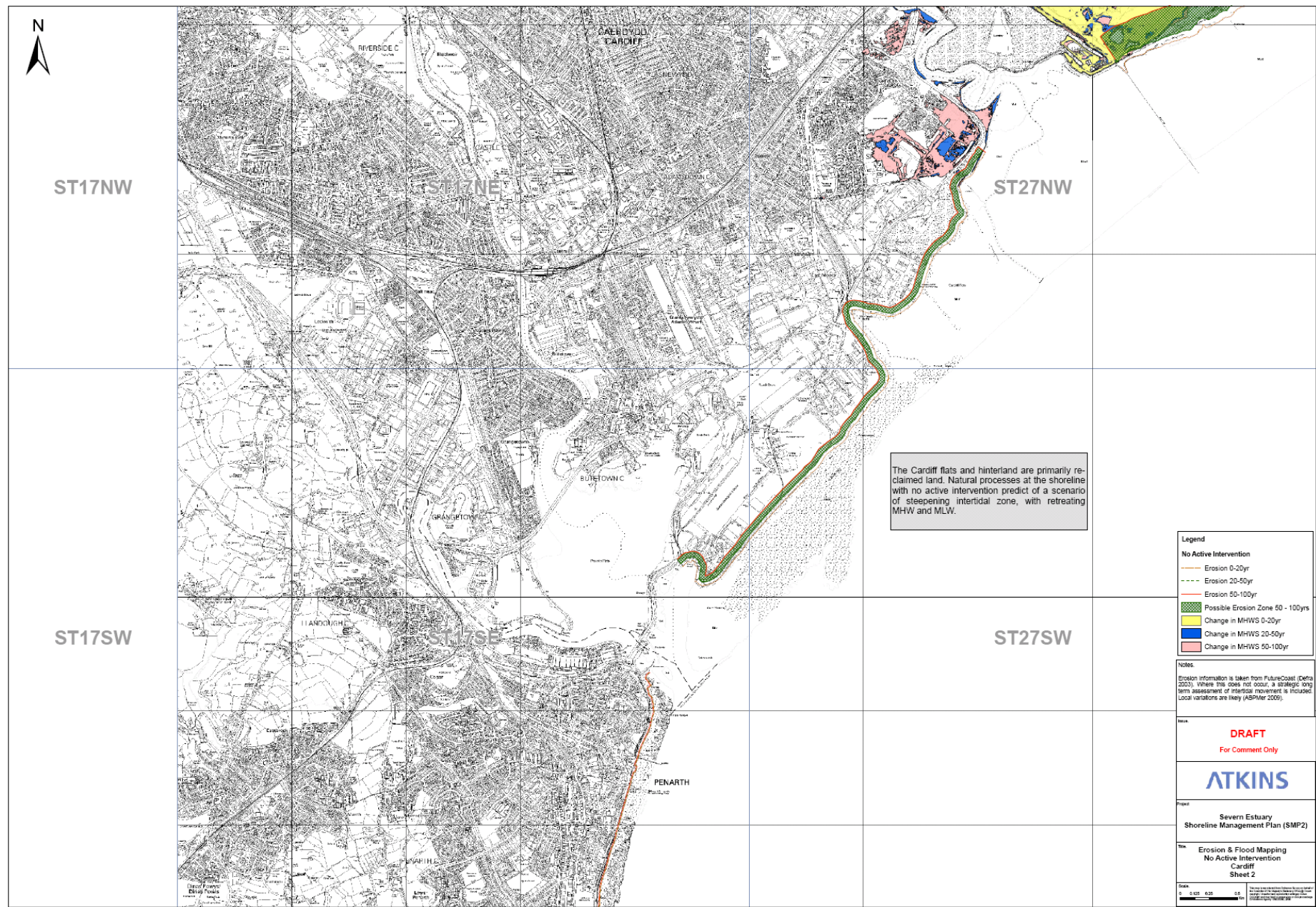

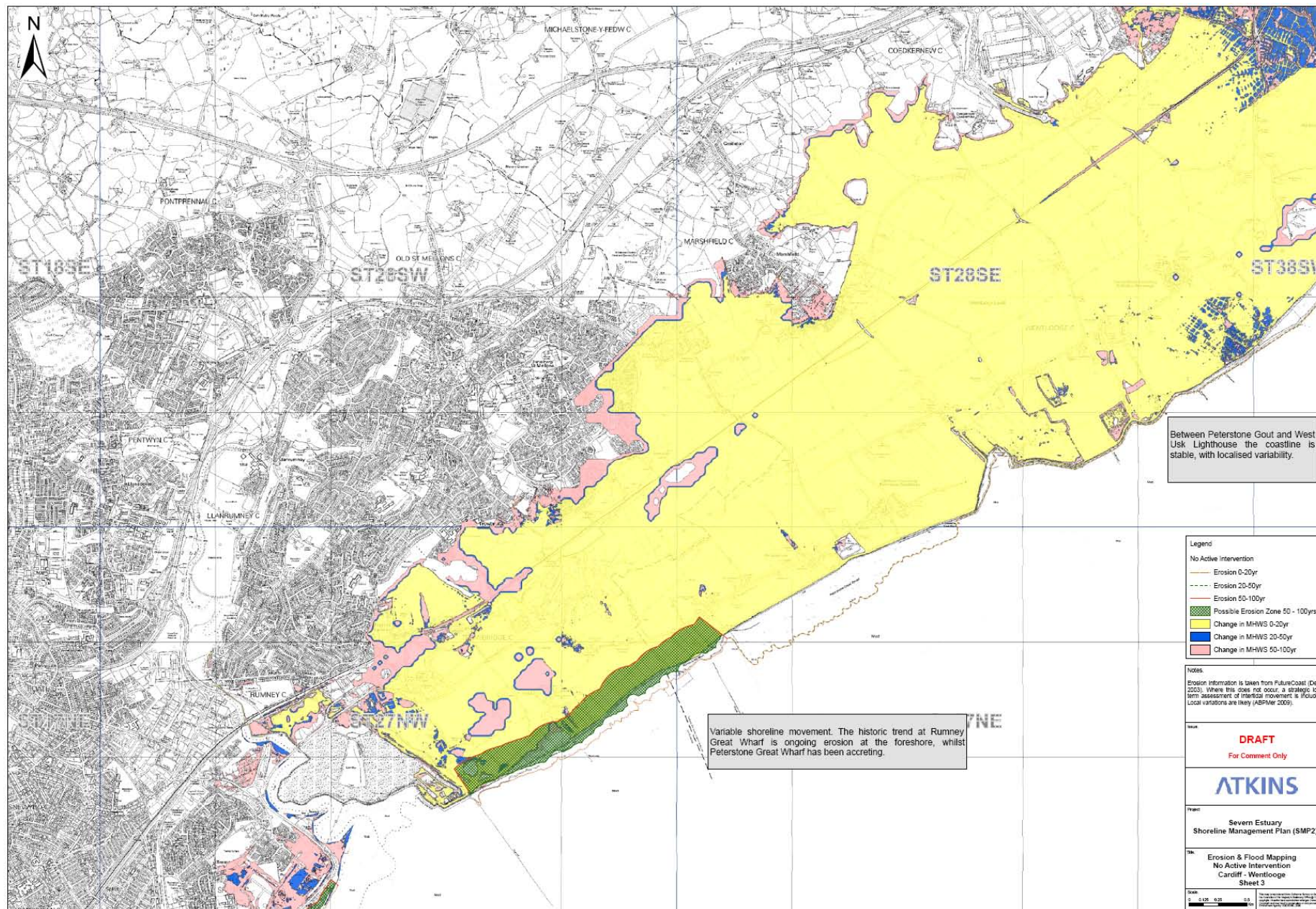

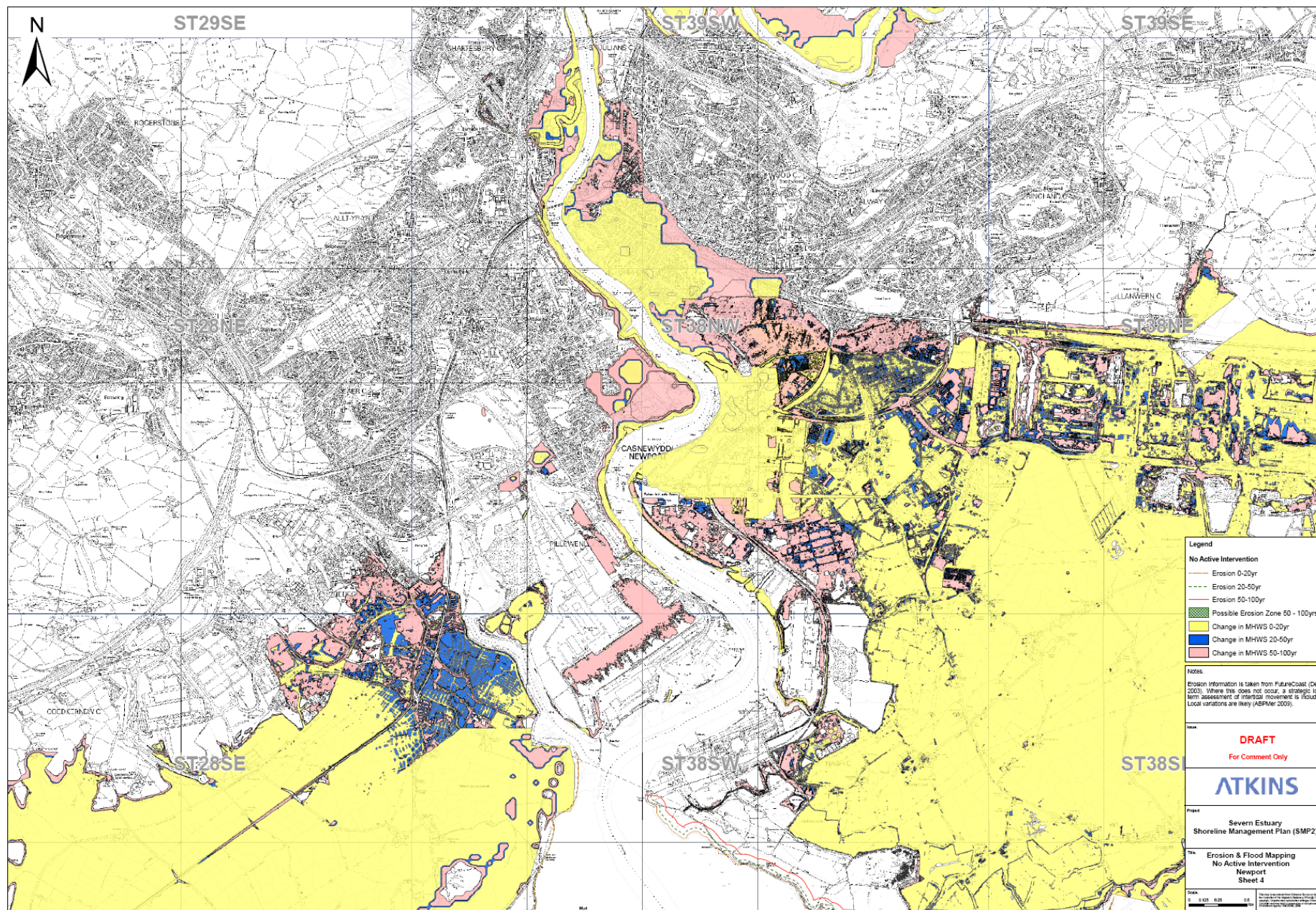

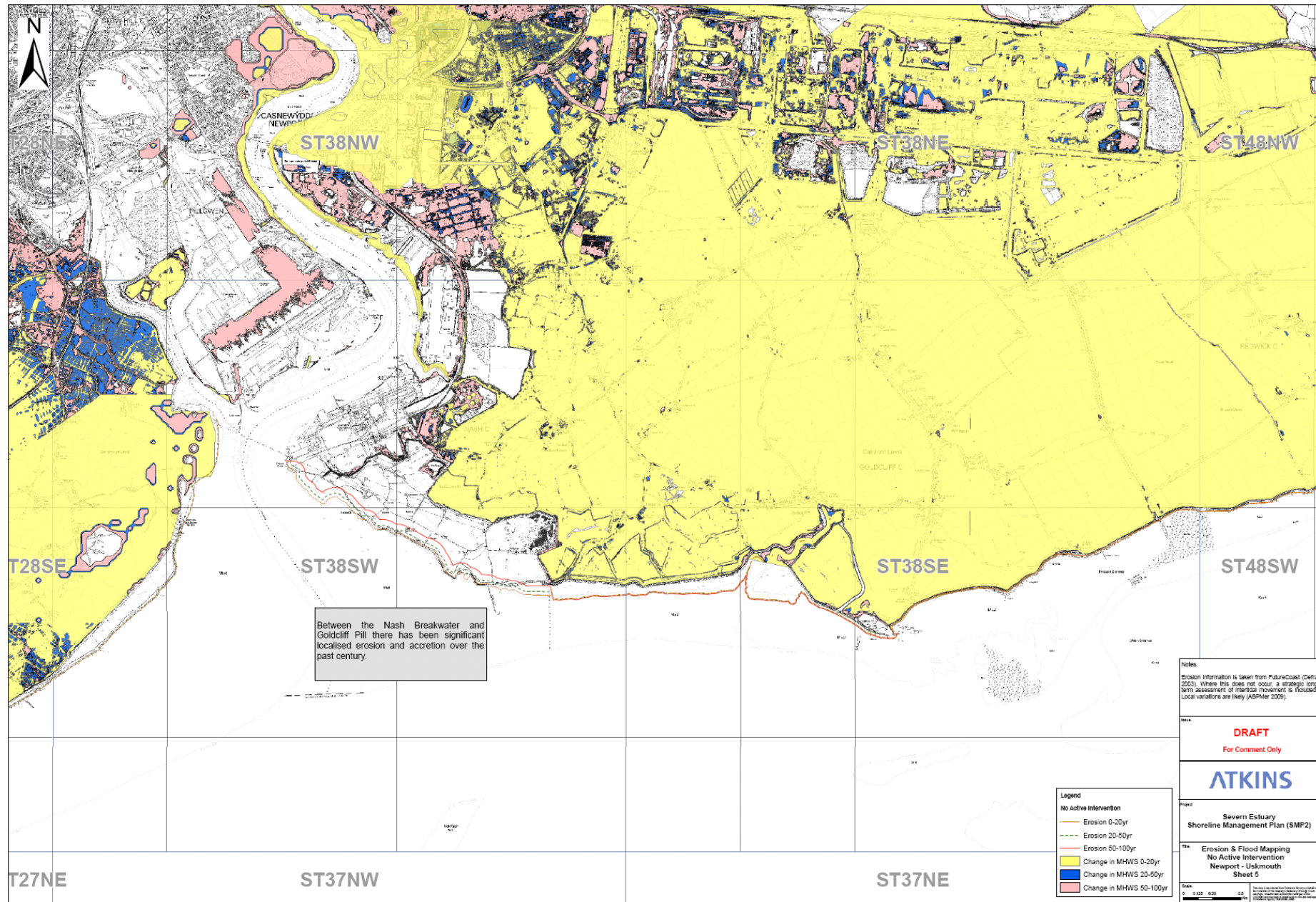

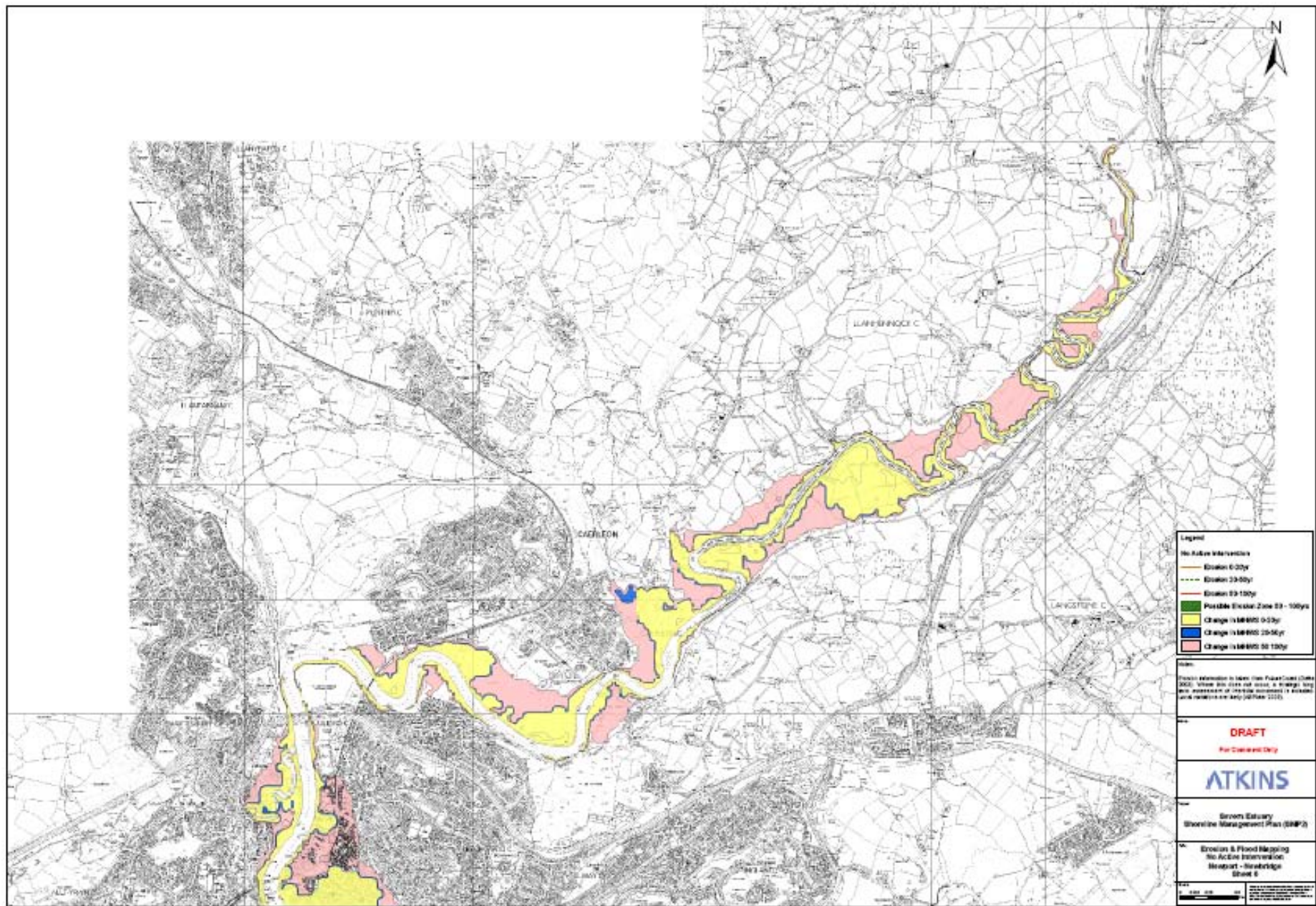

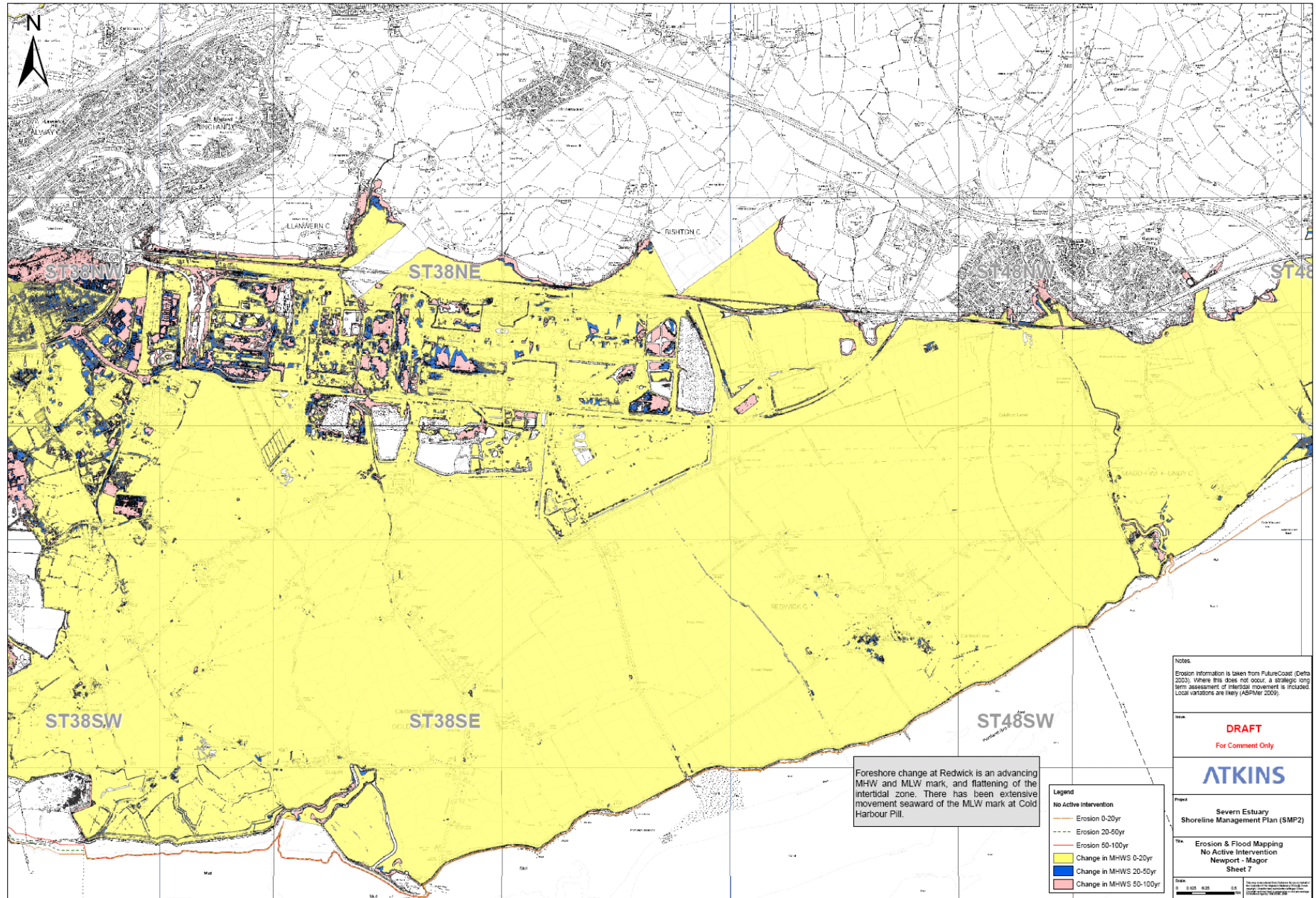

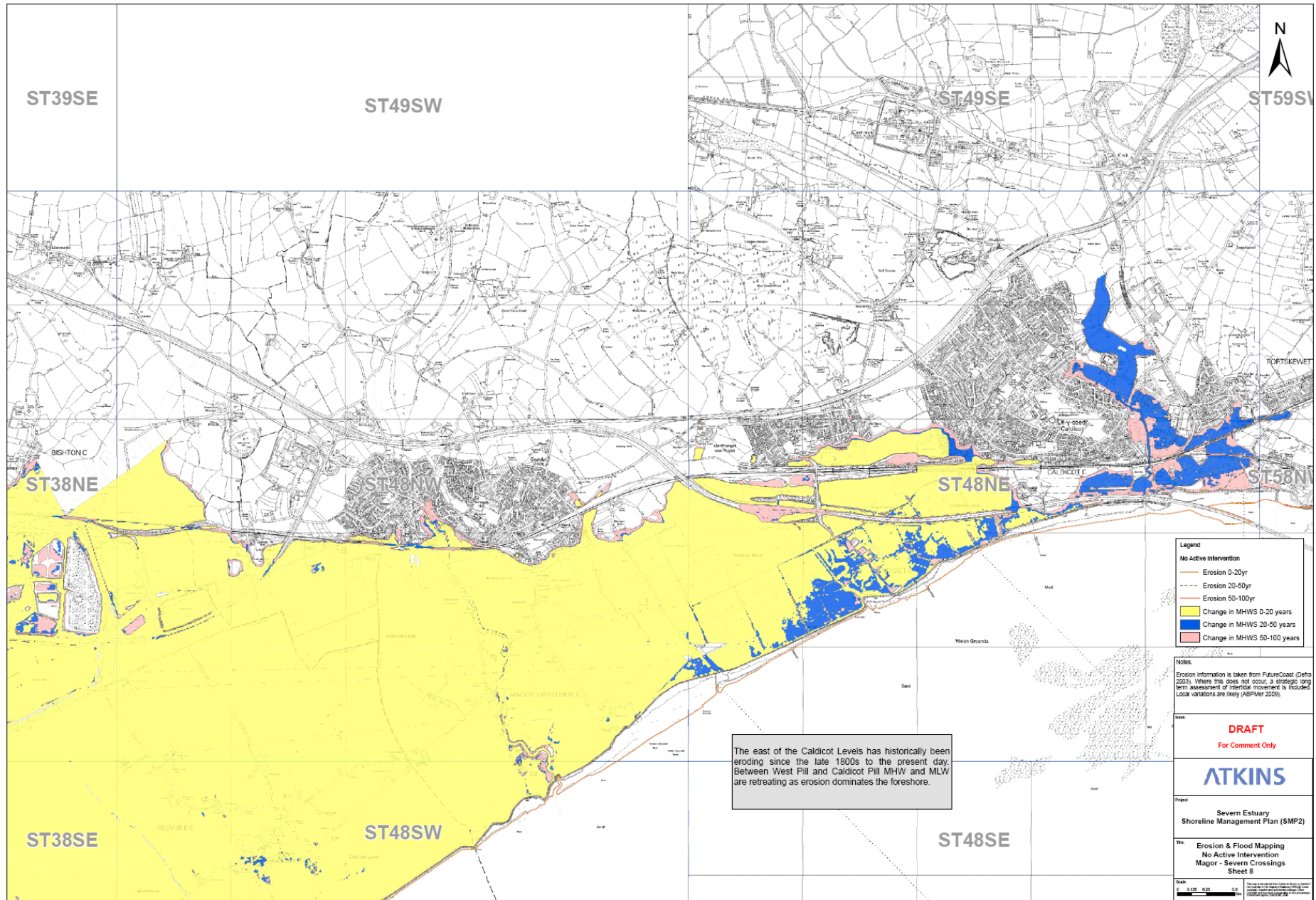

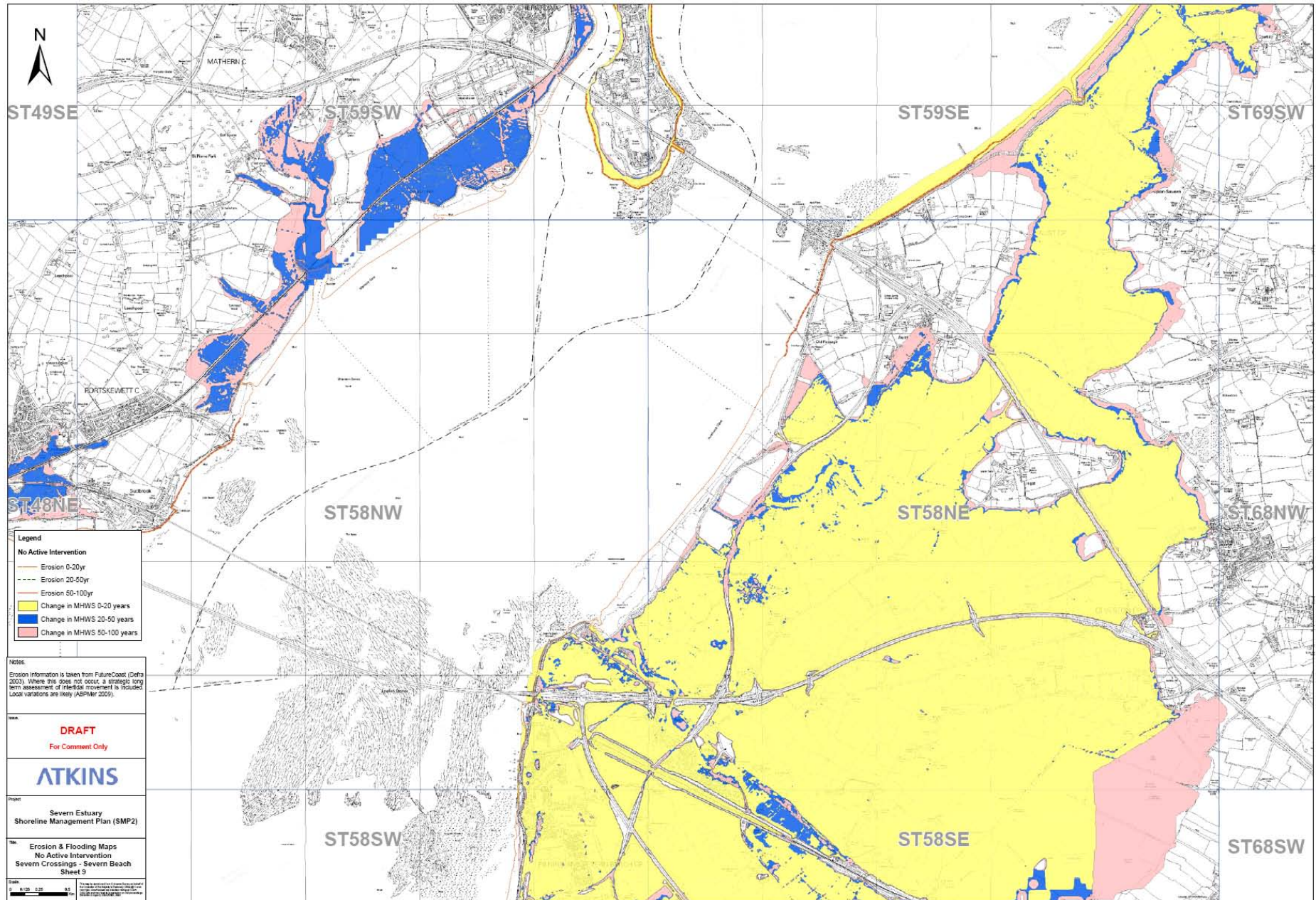

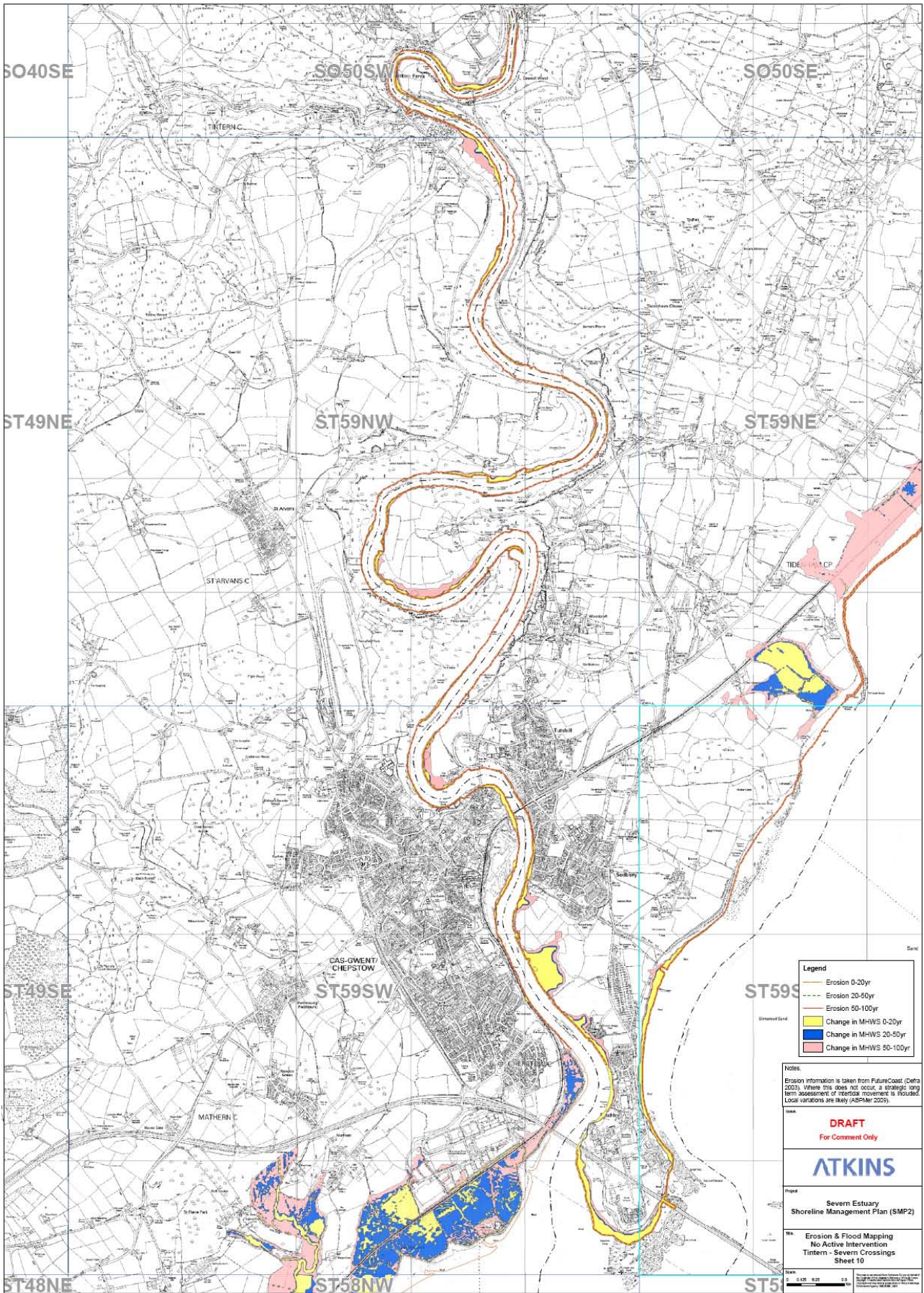

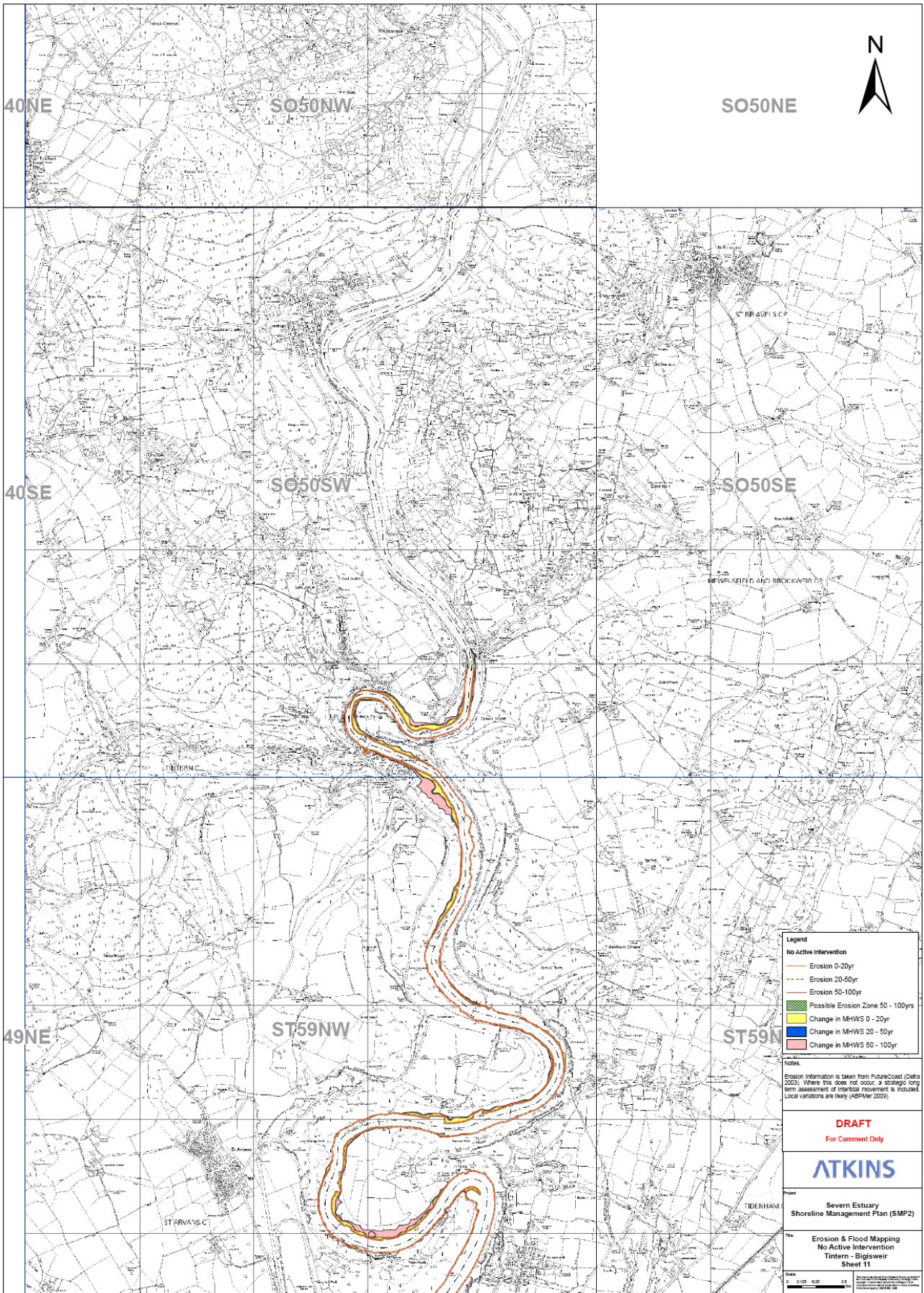

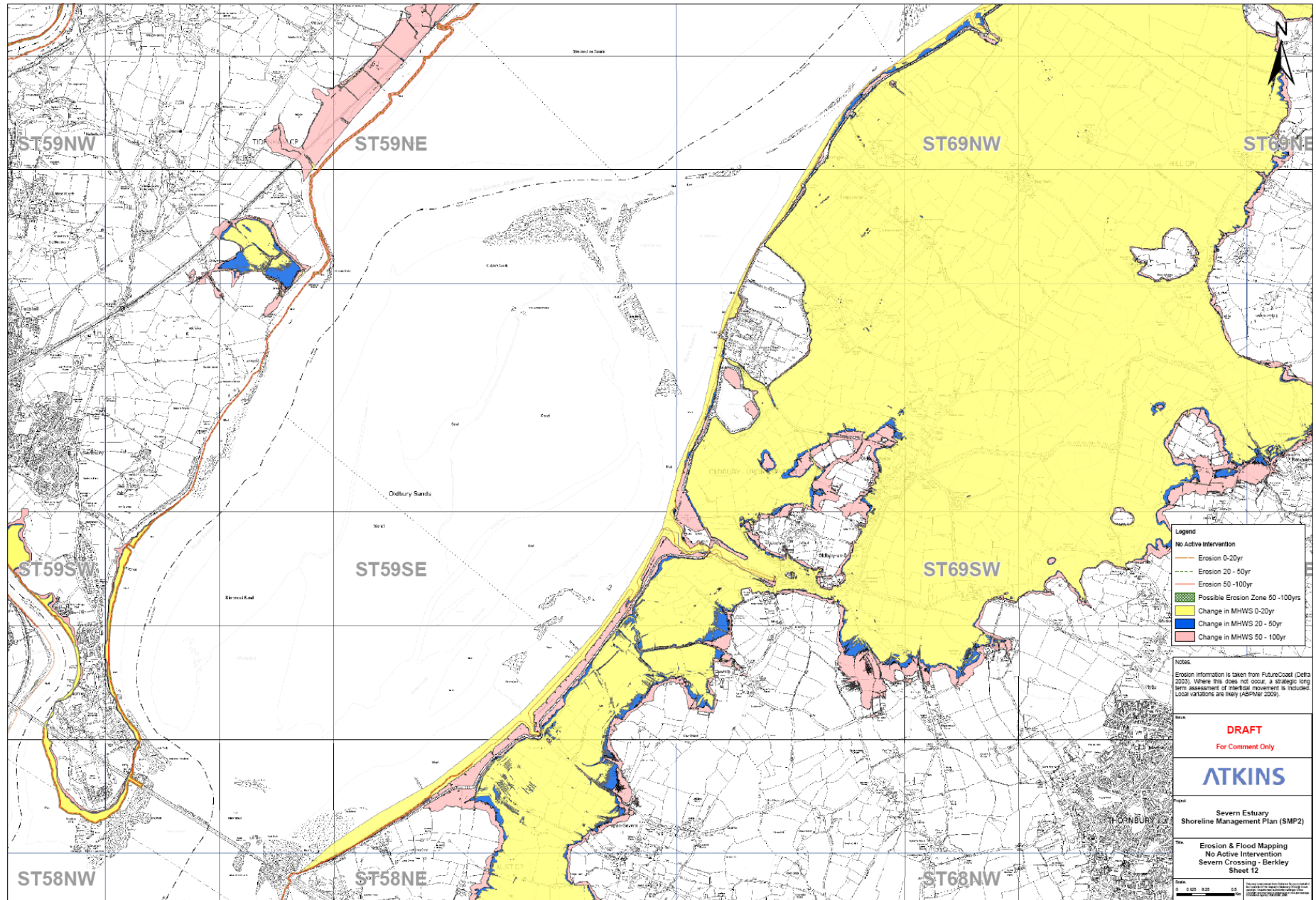

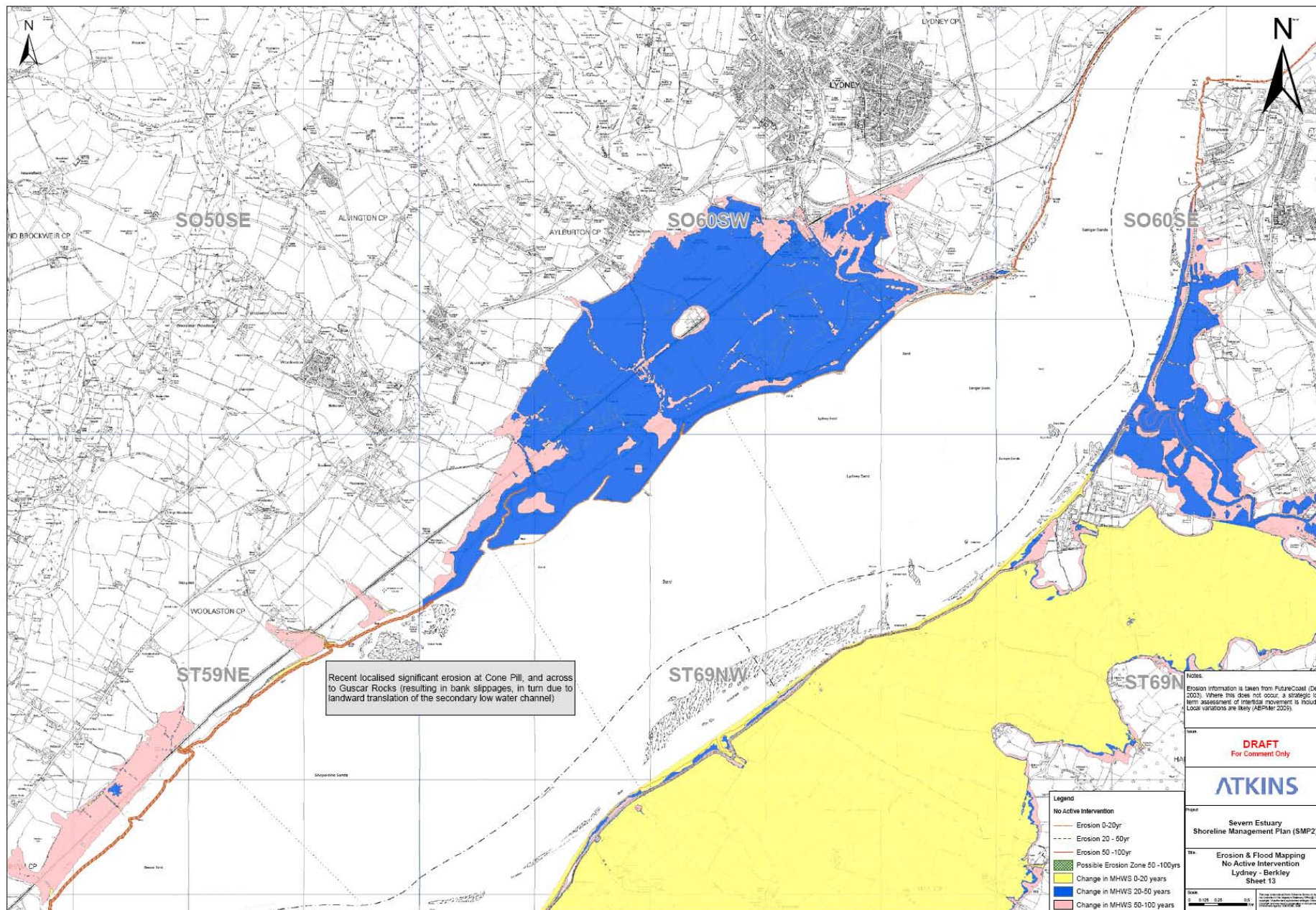

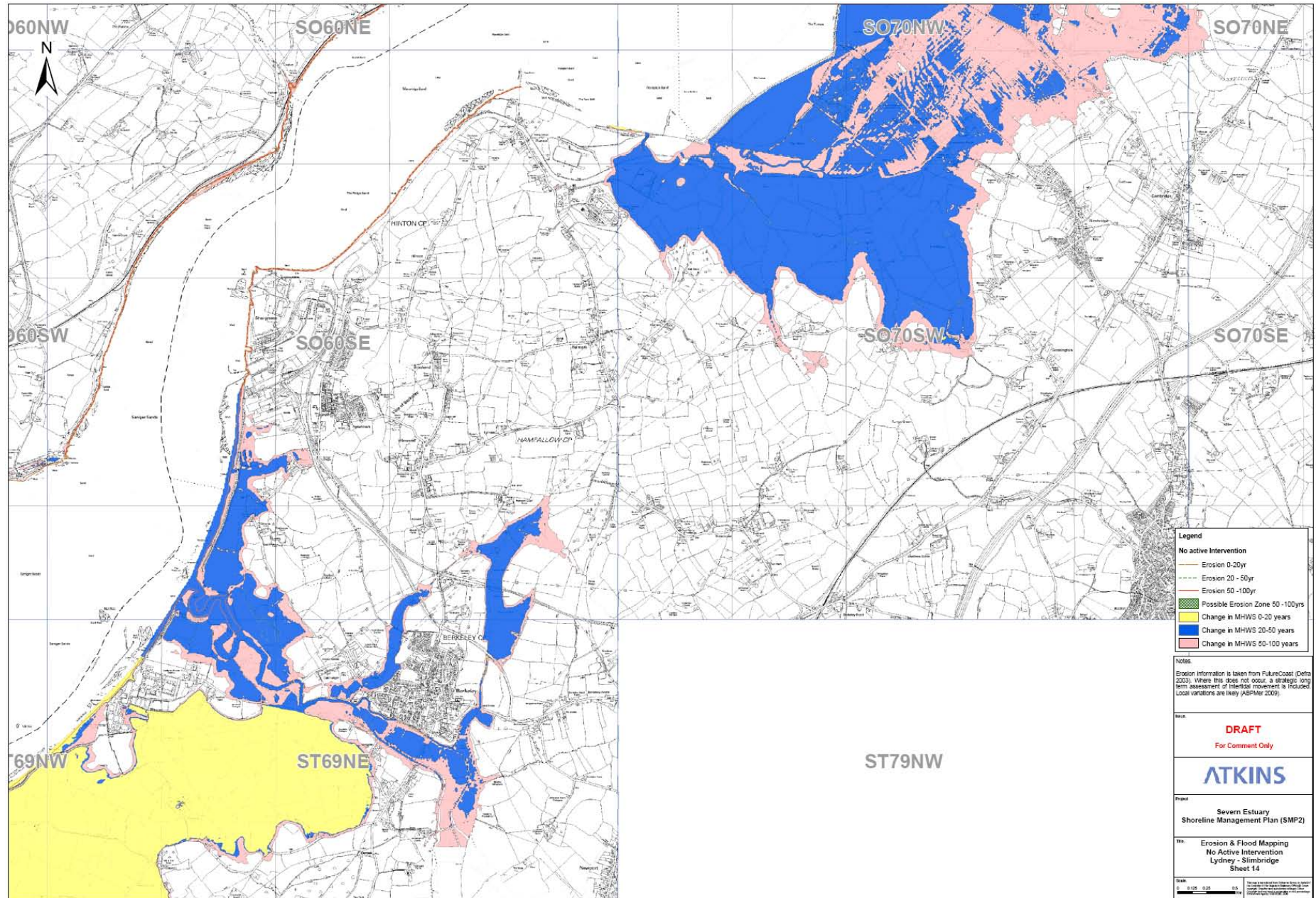

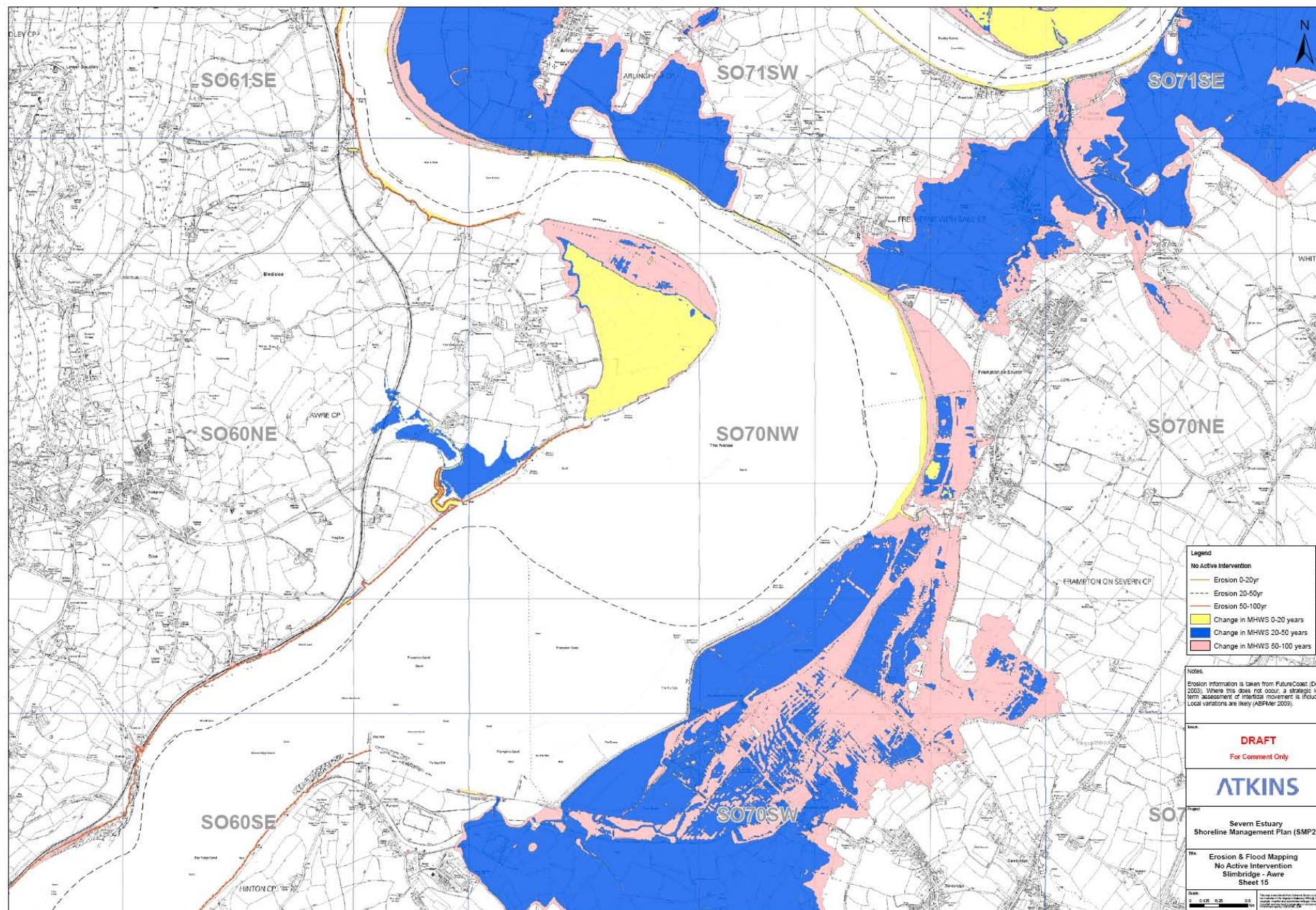

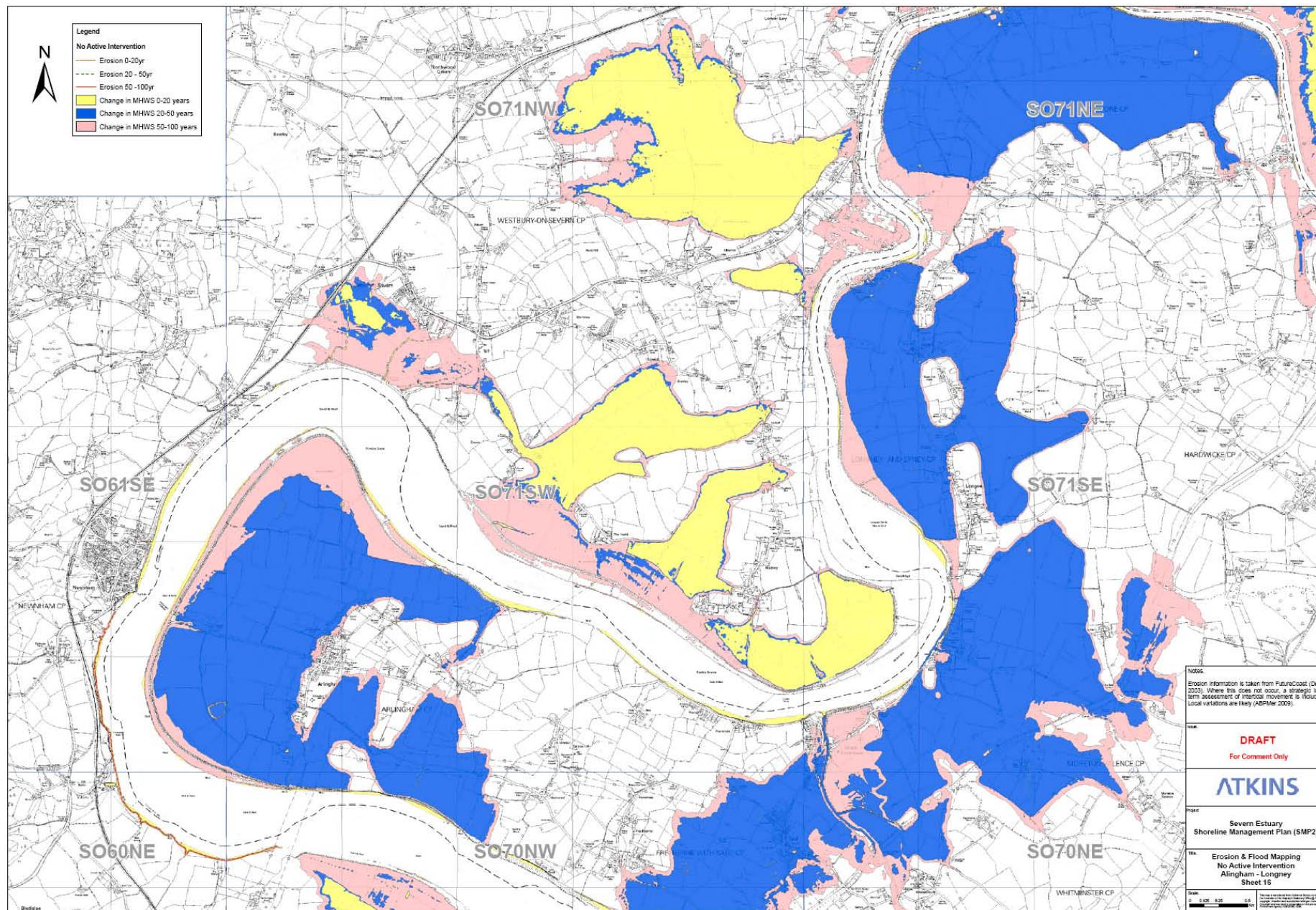

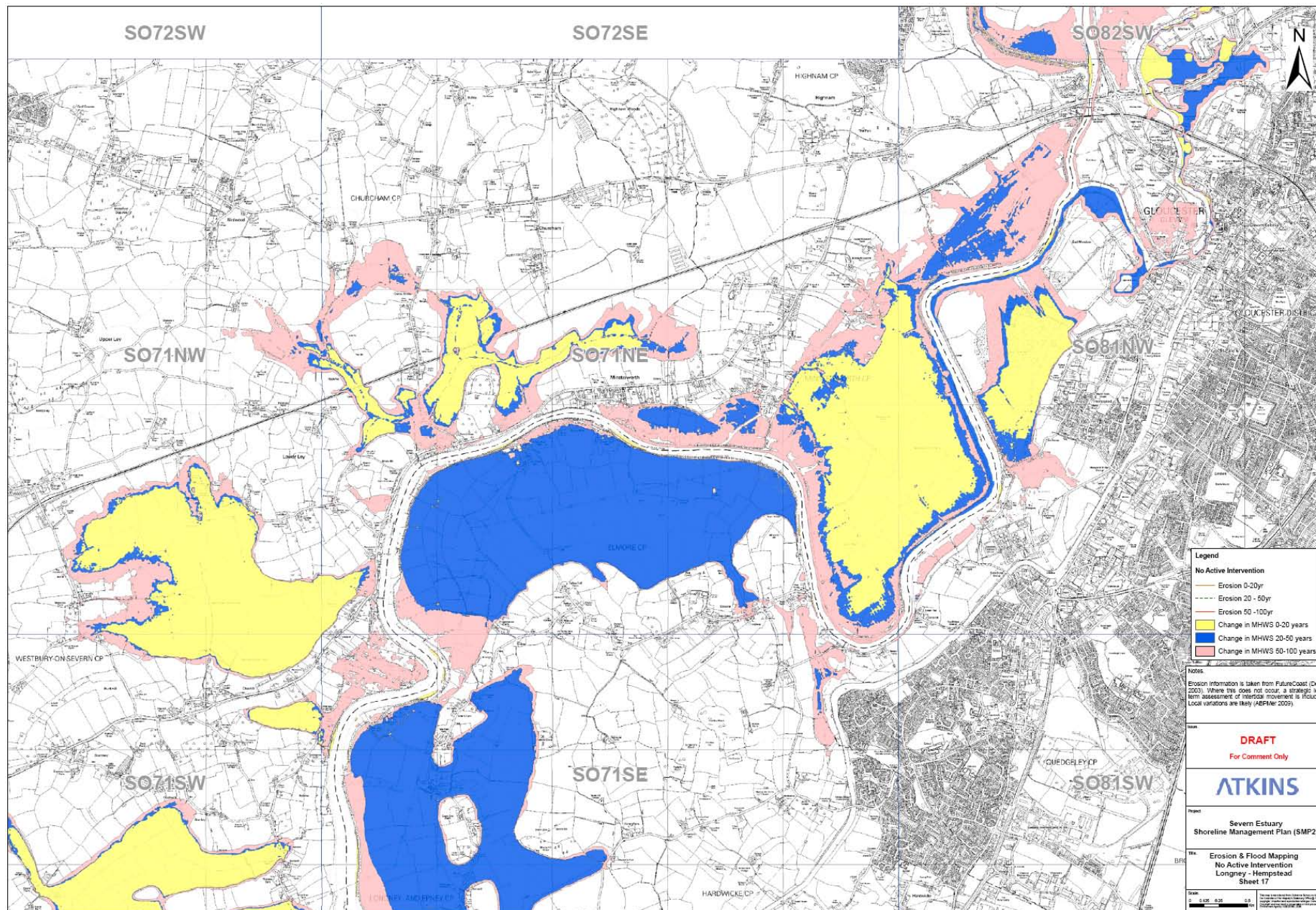

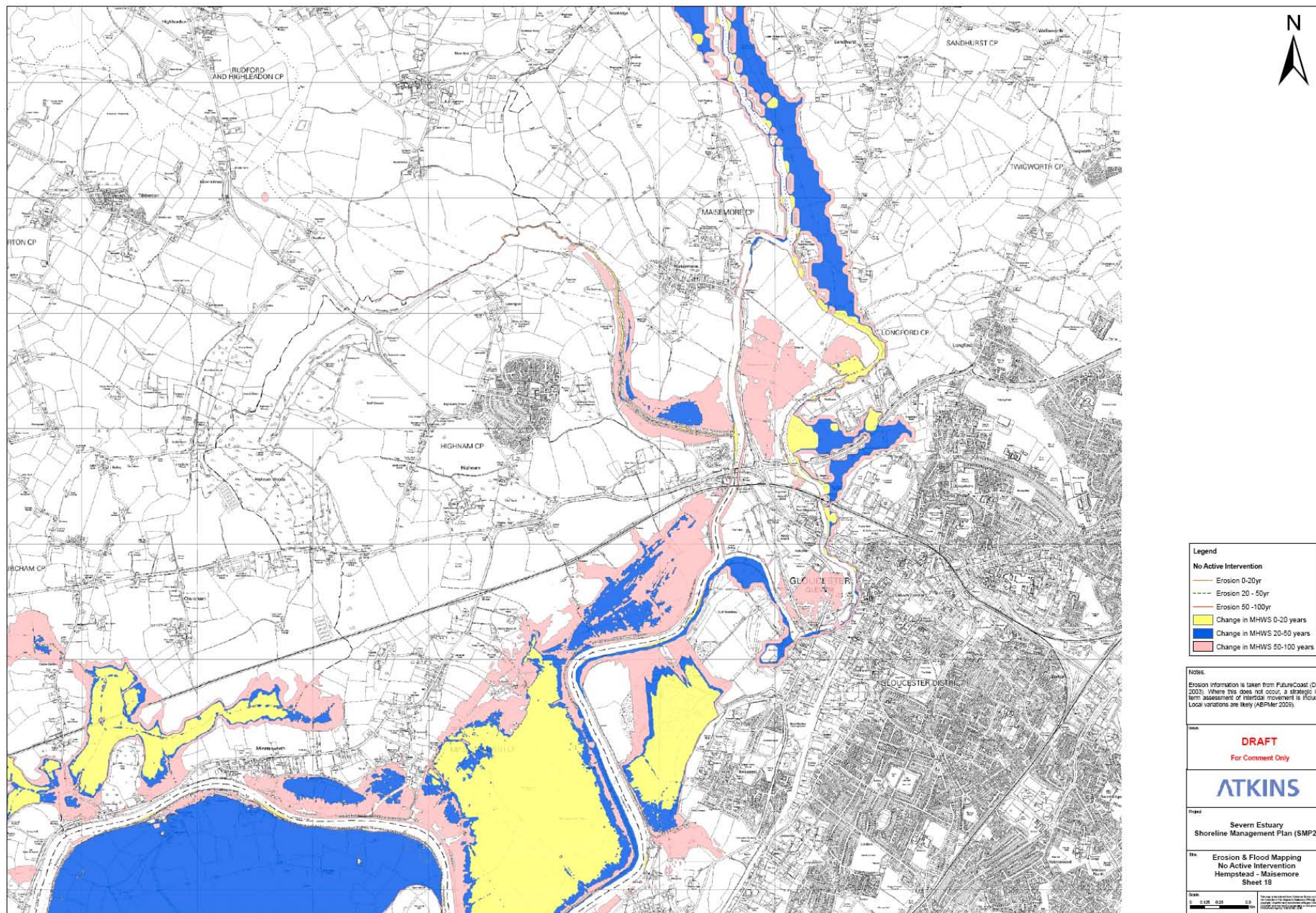

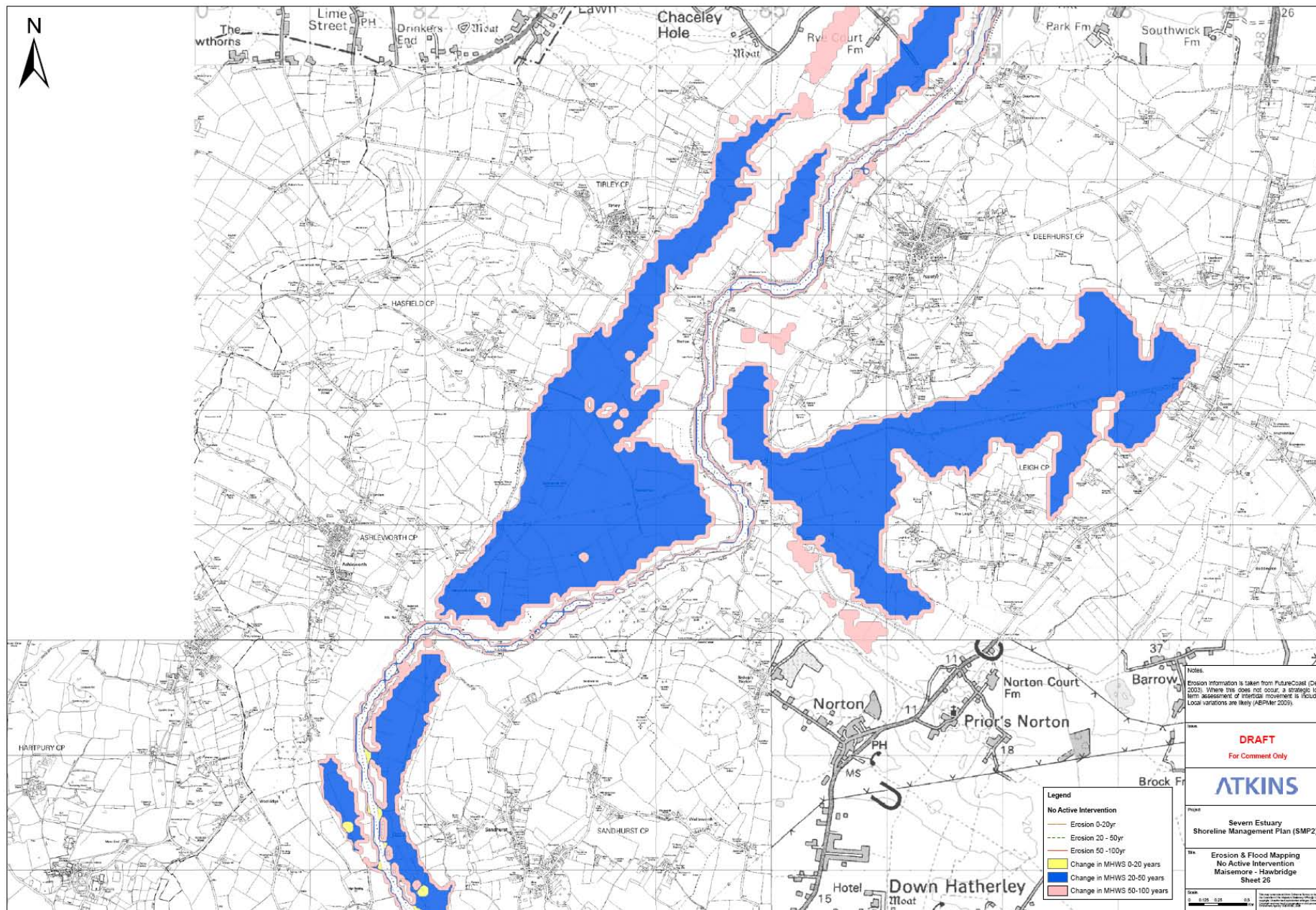

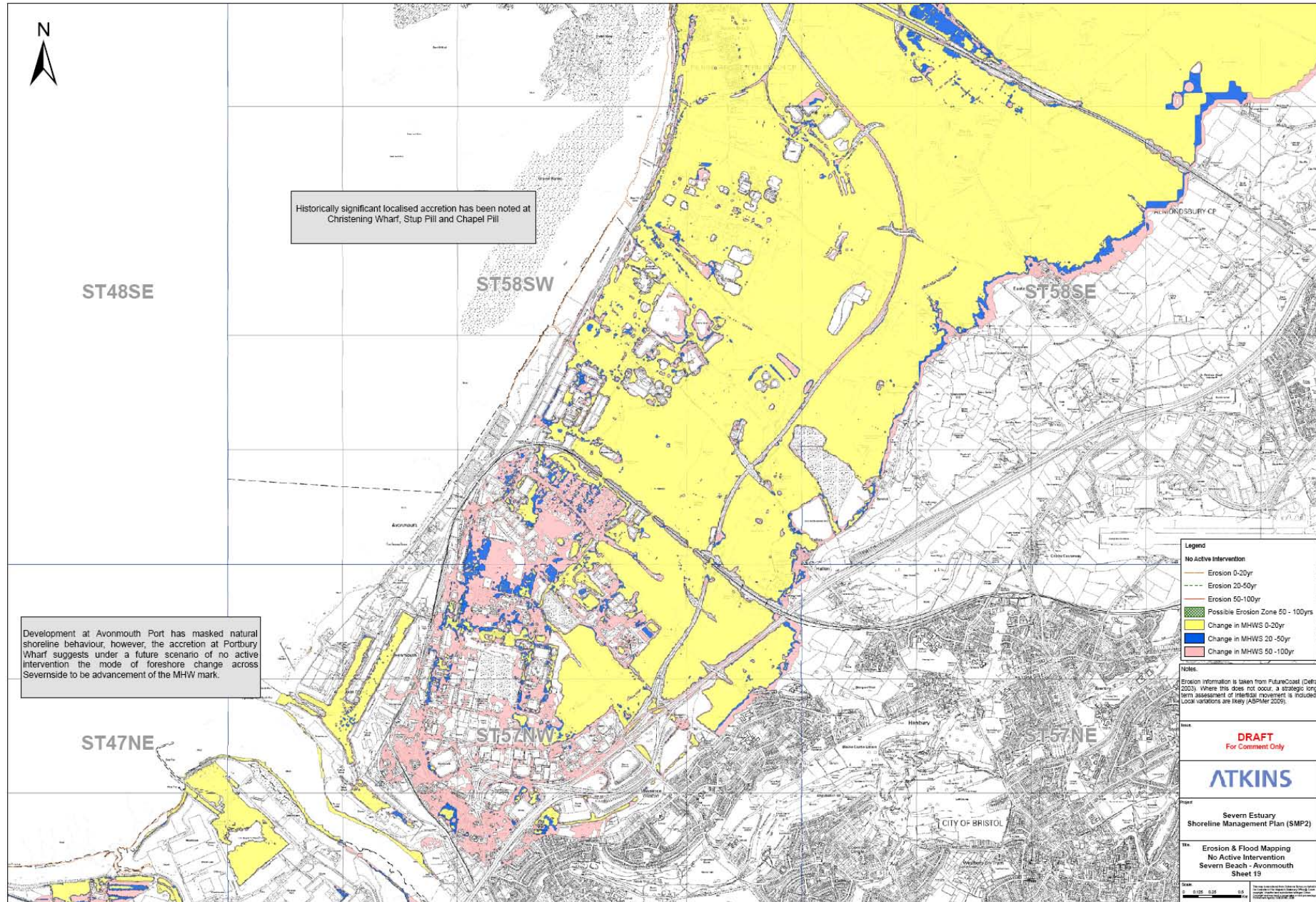

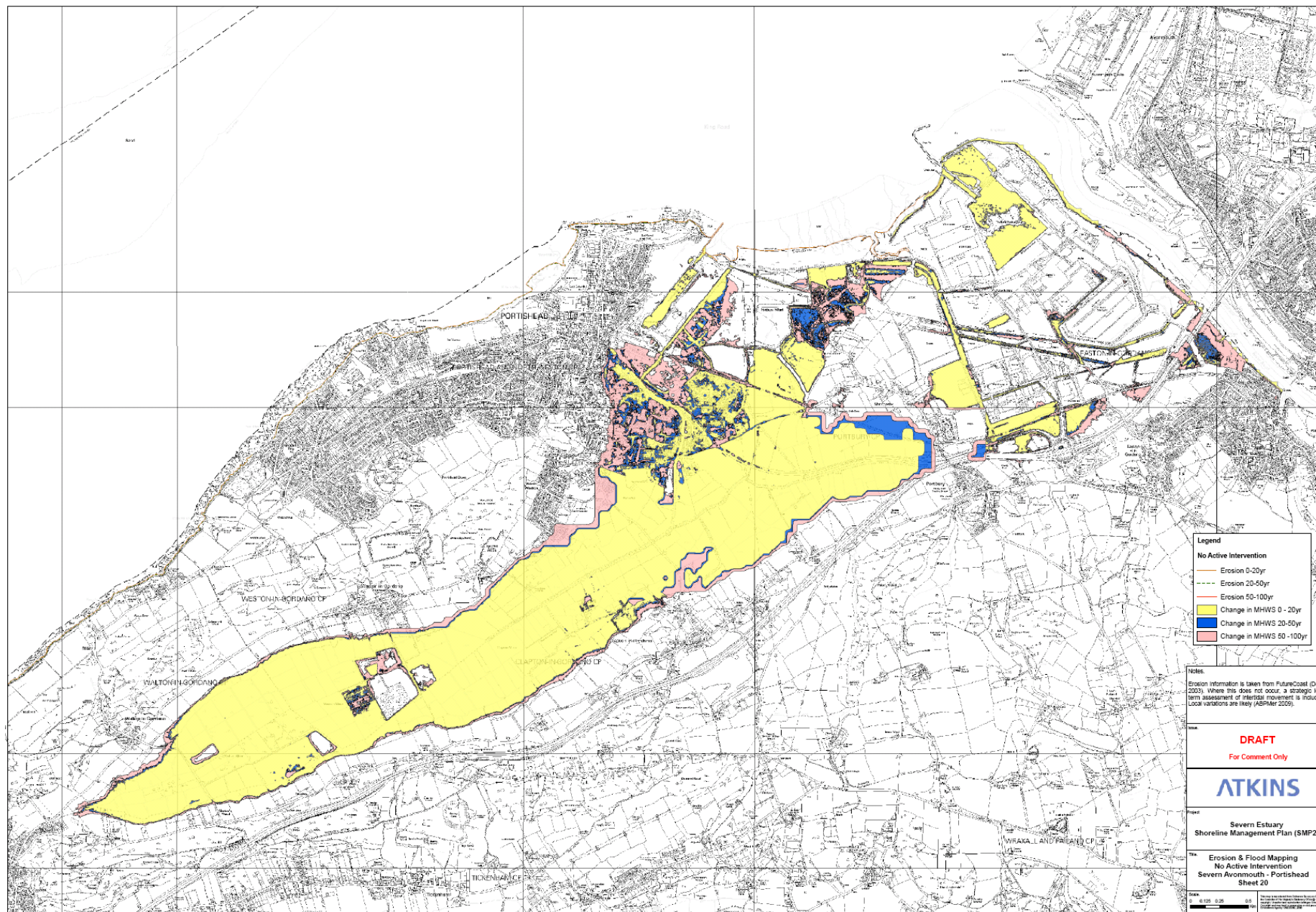



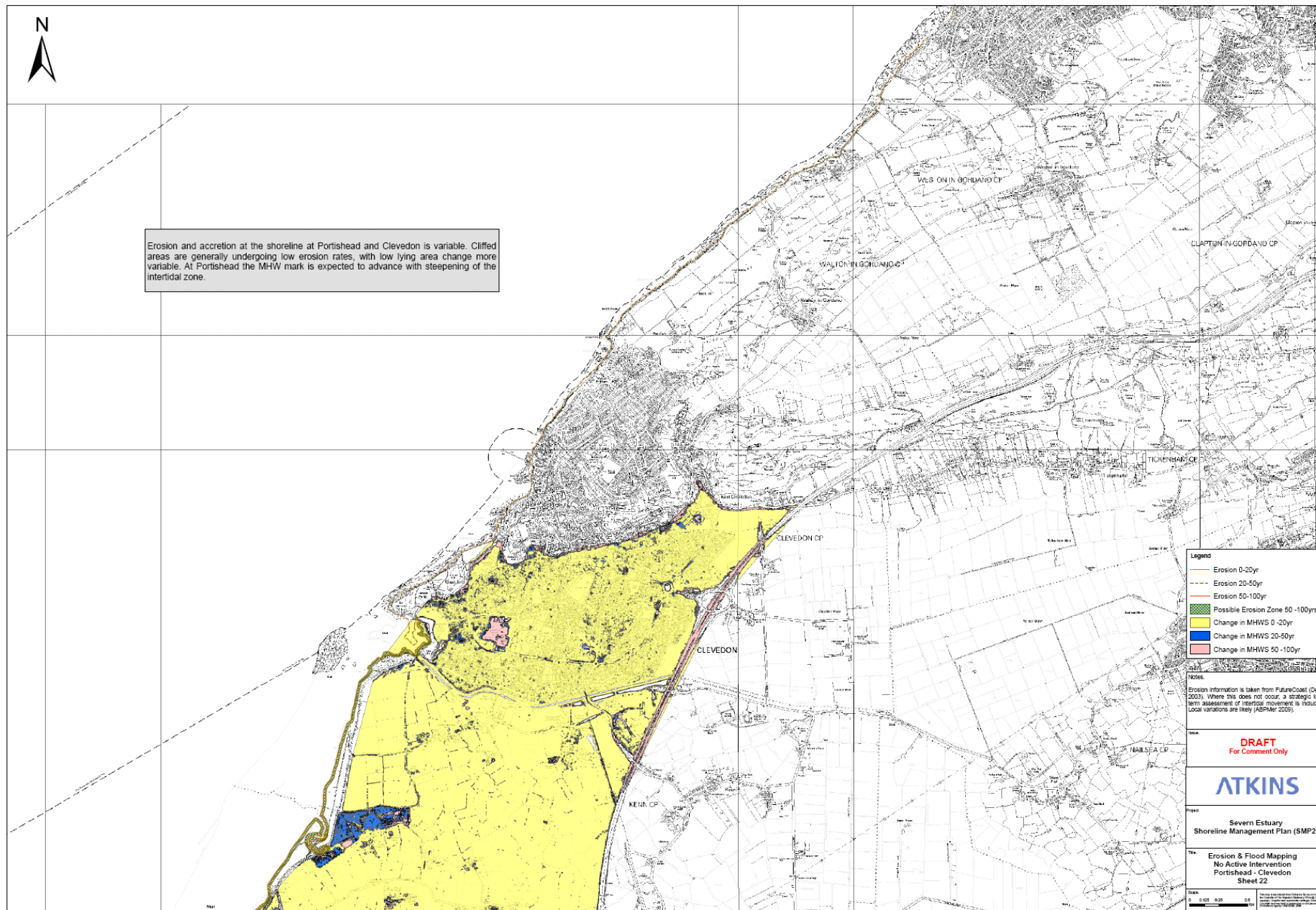

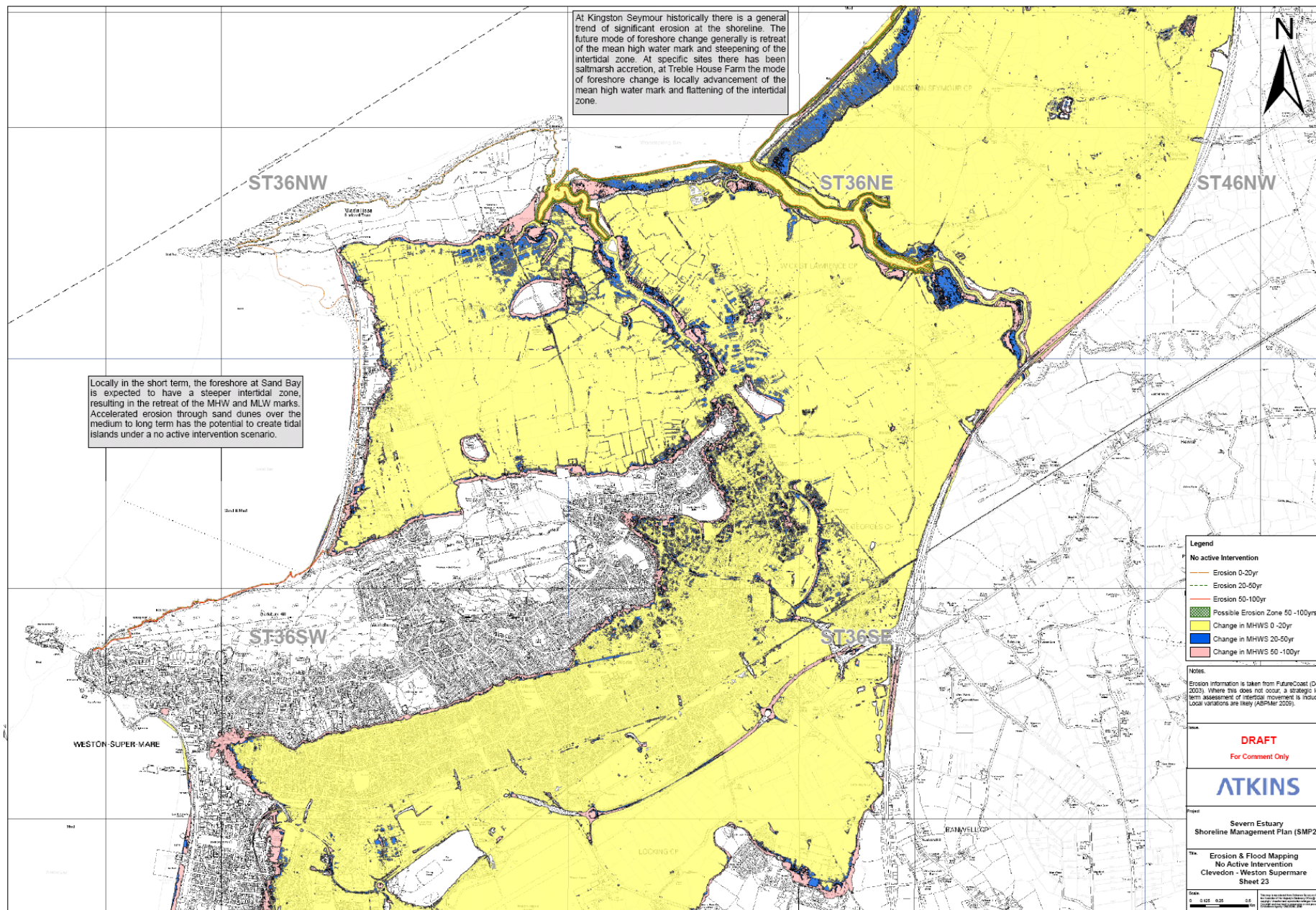

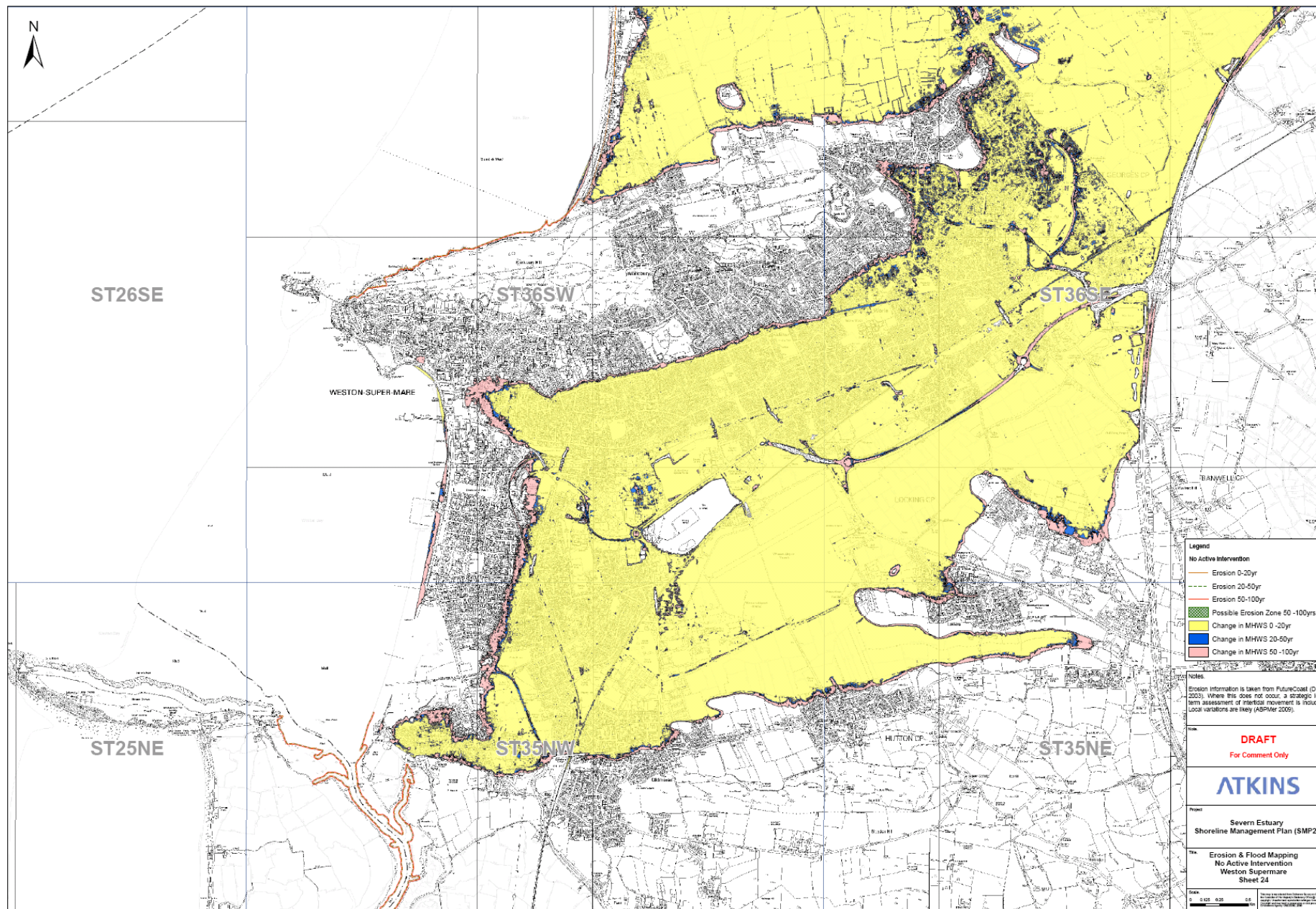

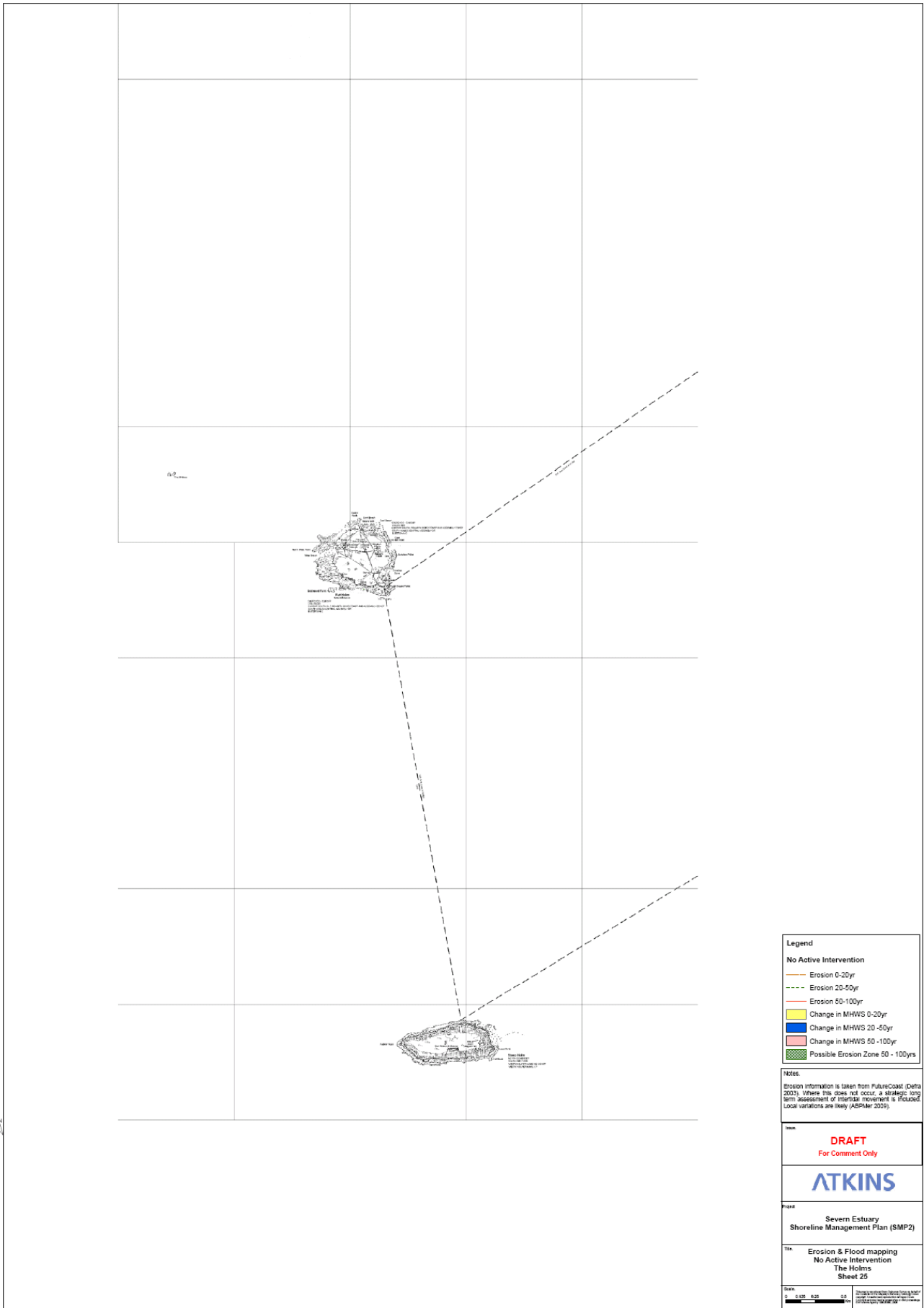

Annex C With Present Management Mapping

NB: The following maps show the location of SMP1 Management Units to depict where the limitations of where existing policies exist.

